



Forceps
Pinzetten
Pinzas
Pinces
Pinze



Fig. 01

09-100-01
12 cm, 4³/₄"

Fine points
 Fine spitzen
 Puntas finas
 Pointes fines
 Punta fini



Fig. 02

09-100-02
12 cm, 4³/₄"



Fig. 03

09-100-03
12 cm, 4³/₄"

Extra fine points
 Extra fine spitzen
 Puntas extra finas
 Pointes èrès fines
 Punta extra fini

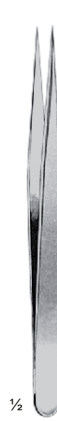

Fig. 3c

09-100-3C
11 cm, 4³/₄"

Extra fine points
 Extra fine spitzen
 Puntas extra finas
 Pointes èrès fines
 Punta extra fini



Fig. 3x

09-100-3X
12 cm, 4³/₄"



Fig. 04

09-100-04
11 cm, 4³/₈"

Extra fine points
 Extra fine spitzen
 Puntas extra finas
 Pointes èrès fines
 Punta extra fini



Fig. 05

09-100-05
11 cm, 4³/₈"

Super fine points
 Superfeine spitzen
 Puntas super finas
 Pointes superfines
 Punta super fini



Fig. 5s

09-100-5S
11 cm, 4³/₈"

Super fine points
 Superfeine spitzen
 Puntas super finas
 Pointes superfines
 Punta super fini



Fig. 5x

09-100-5X
11 cm, 4³/₈"



Fig. 06

09-100-06
11 cm, 4³/₈"



Fig. 07

09-100-07
11 cm, 4³/₈"

Fine points
 Fine spitzen
 Puntas finas
 Pointes fines
 Punta fini



Fig. 7x

09-100-7X
11 cm, 4³/₈"



Fig. 101-11

09-101-11
11,5 cm, 4¹/₂"

1x2 Teeth
 1x2 Zähne
 1x2 Dientes
 1x2 Dents
 1x2 Dentì



Fig. 106-13

09-106-13
13,5 cm, 5¹/₄"

1x2 Teeth
 1x2 Zähne
 1x2 Dientes
 1x2 Dents
 1x2 Dentì



Fig. 108-13

09-108-13
13,5 cm, 5¹/₄"

1x2 Teeth
 1x2 Zähne
 1x2 Dientes
 1x2 Dents
 1x2 Dentì



Fig. 110-09

09-110-09
9,5 cm, 3³/₄"

1x2 Teeth
 1x2 Zähne
 1x2 Dientes
 1x2 Dents
 1x2 Dentì



Micro Suture Tying Forceps

Mikro-Knüpfpinzetten
 Micro-pinzas de ligadura
 Micro-pinces à ligatures
 Micro-pinze per legature



09

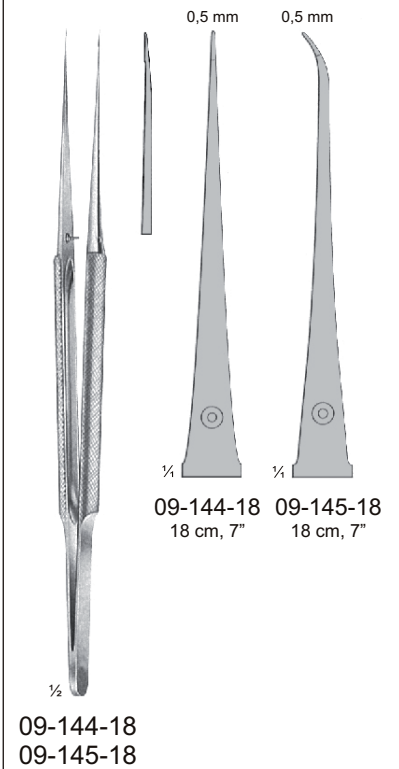
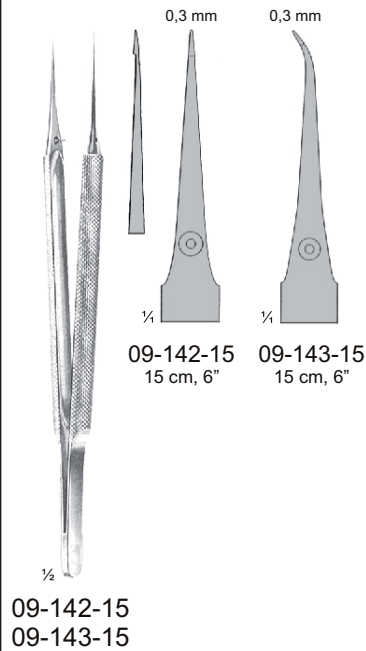
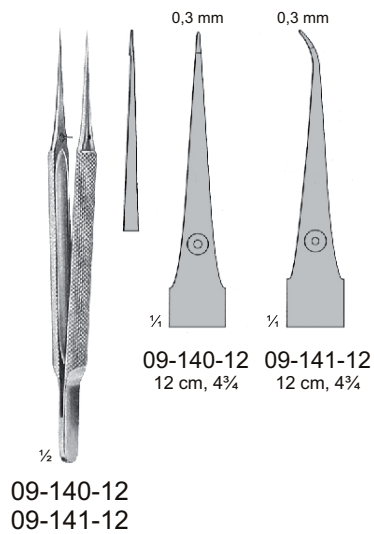
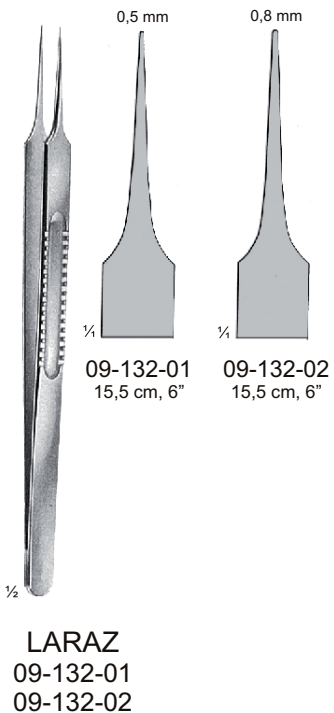
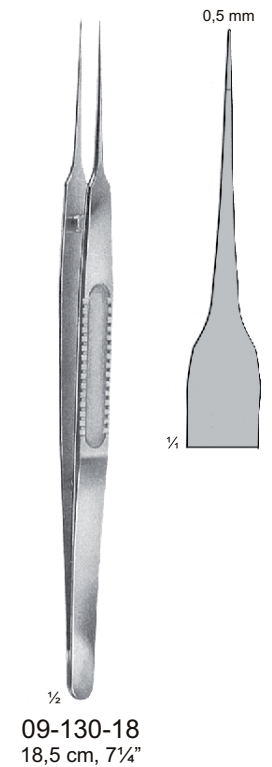
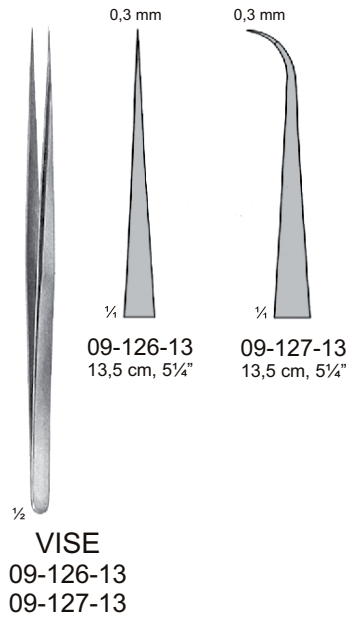
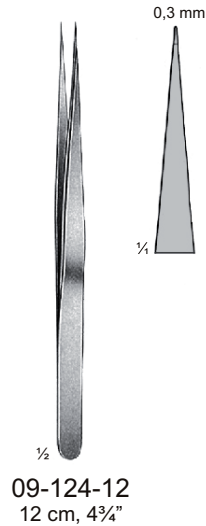
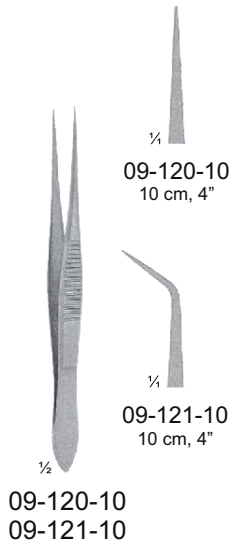



Micro, Tumor and Tissue Grasping Forceps, bayonet-shaped

Mikro, Tumor-und Gewebefäßpinzetten, bajoettförmig
 Micro, Pinzas de agarre para tejido y tumor, en forma bayoneta
 Micro, Pincas en forme de baïonnette pour saisir tumeurs et tissus
 Micro, Pinze per afferare tessuti e tumori, a baionetta



09



YASARGIL
 09-150-18
 09-152-24

With smooth jaws
 Mit glatten maulteilen
 Con bocas lisas
 Avec mors lisses
 Con morsi lisci

0,4 mm	0,4 mm	0,4 mm	0,4 mm
1/4	1/4	1/4	1/4
09-150-18 18 cm, 7"	09-150-20 20 cm, 8"	09-150-22 22 cm, 8 3/4"	09-150-24 24,5 cm, 9 3/4"
0,9 mm	0,9 mm	0,9 mm	0,9 mm
1/4	1/4	1/4	1/4
09-152-18 18 cm, 7"	09-152-20 20 cm, 8"	09-152-22 22 cm, 8 3/4"	09-152-24 24,5 cm, 9 3/4"



1/4

YASARGIL
 09-156-18
 18 cm, 7"

1x2 Teeth
 1x2 Zähne
 1x2 Dientes
 1x2 Dents
 1x2 Denti

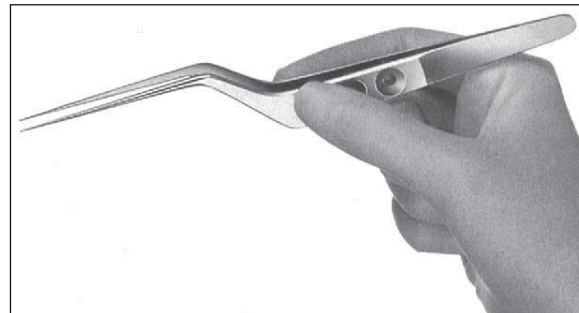

YASARGIL
 09-162-01
 09-168-03

3 mm	5 mm	3 mm	5 mm	3 mm	5 mm	7 mm
1/4	1/4	1/4	1/4	1/4	1/4	1/4
09-162-01 22 cm, 3/4"	09-162-02 22 cm, 3/4"	09-164-01 22 cm, 3/4"	09-164-02 22 cm, 3/4"	09-168-01 24 cm, 9 3/4"	09-168-02 24 cm, 9 3/4"	09-168-03 24 cm, 9 3/4"

Flat jaws, serrated
 Maul flach, gezahnt
 Boca plana, dentada
 Mors plats, Dentelés
 Morsi piatti, dentati

Jaws spoon-shaped
 Maul löffelförmig
 Boca forma cuchara
 Mors en forme de cuillère
 Morsi a forma di cucchiaio

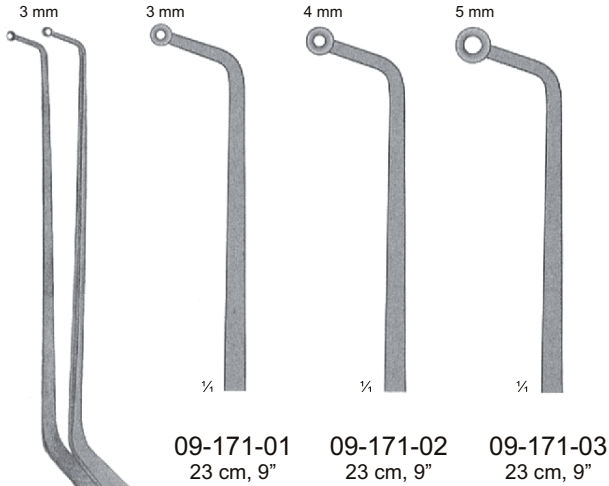

Jaws spoon-shaped
 Maul löffelförmig
 Boca forma cuchara
 Mors en forme de cuillère
 Morsi a forma di cucchiaio

½
SAMII
 09-171-01
 09-171-03

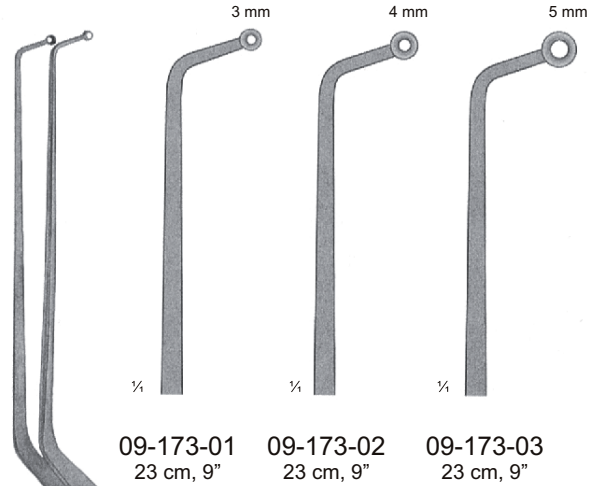

Jaws spoon-shaped
 Maul löffelförmig
 Boca forma cuchara
 Mors en forme de cuillère
 Morsi a forma di cucchiaio

½
SAMII
 09-173-01
 09-173-03

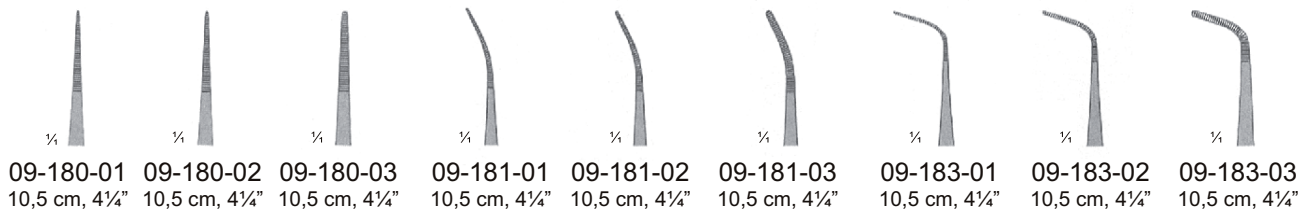

09-180-01
 09-183-03

Delicate Dissecting Forceps
 Feine anatomische pinzetten
 Pinzas finas de disección
 Pincas fines pour dissection
 Pinze anatomiche per dissezione, fini



Delicate Dissecting Forceps
Feine anatomische pinzetten
Pinzas finas de disección
Pincas fines pour dissection
Pinze anatomiche per dissezione, fini



09

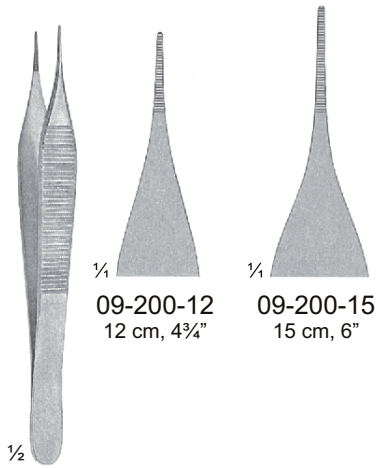

09-200-12
12 cm, 4³/₄"

09-200-15
15 cm, 6"

1/2
**MICRO
ADSON**
09-200-12
09-200-15

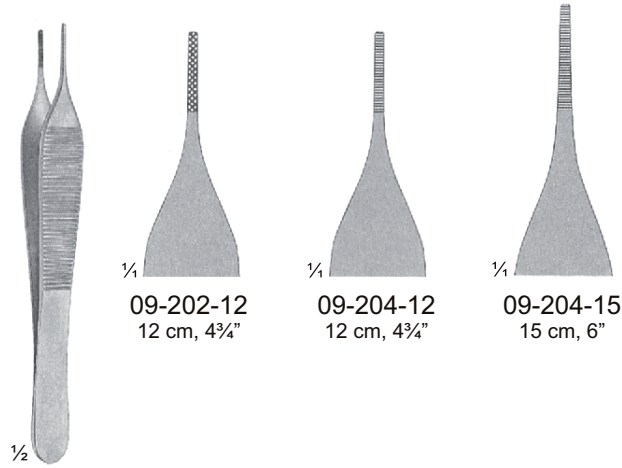

09-202-12
12 cm, 4³/₄"

09-204-12
12 cm, 4³/₄"

09-204-15
15 cm, 6"

1/2
MINI ADSON
09-202-12
09-204-15

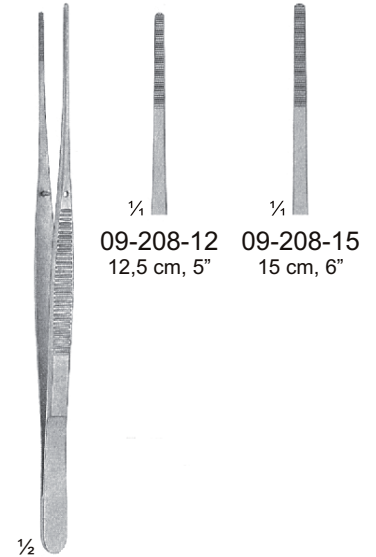

09-208-12
12,5 cm, 5"

09-208-15
15 cm, 6"

1/2
SEMKEN
09-208-12
09-208-15

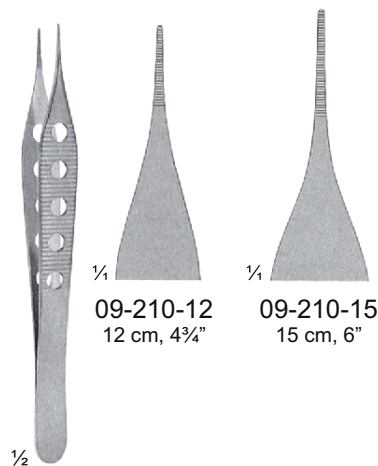

09-210-12
12 cm, 4³/₄"

09-210-15
15 cm, 6"

1/2
**MICRO
ADSON**
09-210-12
09-210-15

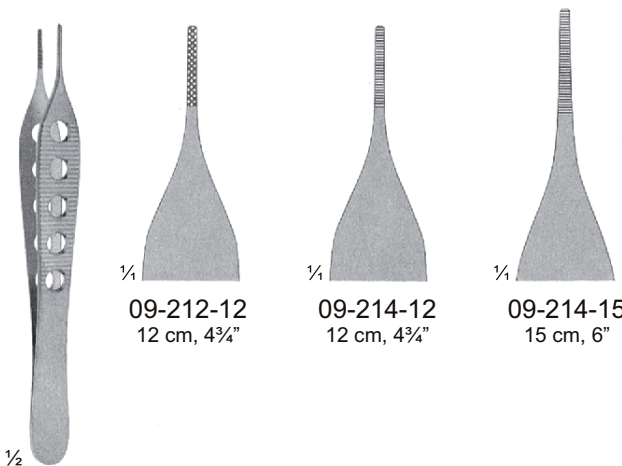

09-212-12
12 cm, 4³/₄"

09-214-12
12 cm, 4³/₄"

09-214-15
15 cm, 6"

1/2
MINI ADSON
09-212-12
09-214-15

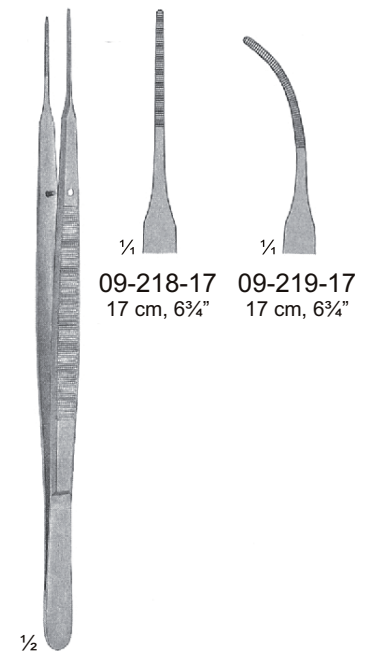

09-218-17
17 cm, 6³/₄"

09-219-17
17 cm, 6³/₄"

1/2
GERALD
09-218-17
09-219-17

Delicate Dissecting Forceps

Feine anatomische pinzetten
 Pinzas finas de disección
 Pincas finas pour dissection
 Pinze anatomiche per dissezione, fini



MC INDOE
 09-224-15
 15 cm, 6"



TAYLOR
 09-228-17
 09-229-17

With dissector end
 Mit dissektor-ende
 Con cabo disecador
 Avec talon dissecteur
 Con dissettore



09-228-17
 17,5 cm, 7"



09-229-17
 17,5 cm, 7"



TAYLOR-CUSHING
 09-232-17
 17,5 cm, 7"

With dissector end
 Mit dissektor-ende
 Con cabo disecador
 Avec talon dissecteur
 Con dissettore



POTTS-SMITH
 09-236-18
 09-236-30

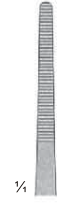

09-236-18
 18 cm, 7"

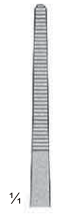

09-236-21
 21 cm, 8¼"



09-236-25
 25 cm, 10"

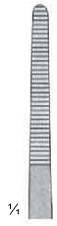

09-236-30
 30 cm, 12"



WAUGH
 09-240-20
 20 cm, 8"



BROPHY
 09-244-20
 09-245-20



09-244-20
 20 cm, 8"



09-245-20
 20 cm, 8"



GILLIES
 09-250-15
 15 cm, 6"



MOD-USA
 09-252-13
 09-252-14



09-252-13
 13 cm, 5"



09-252-14
 14,5 cm, 5½"



¼	¼	¼
09-260-10	09-260-11	09-260-13
09-262-10	09-262-11	09-262-13
10,5 cm, 4¼"	11,5 cm, 4½"	13 cm, 5"

¼	¼	¼
09-266-10	09-266-11	09-266-13
09-268-10	09-268-11	09-268-13
10,5 cm 4¼"	11,5 cm, 4½"	13 cm, 5"

¼	¼	¼
09-260-14	09-260-16	09-260-18
09-262-14	09-262-16	09-262-18
14,5 cm, 5½"	16 cm, 6¼"	18 cm, 7"

¼	¼	¼
09-266-14	09-266-16	09-266-18
09-268-14	09-268-16	09-268-18
14,5 cm, 5½"	16 cm, 6¼"	18 cm, 7"

¼	¼	¼
09-260-20	09-260-25	09-260-30
09-262-20	09-262-25	09-262-30
20 cm, 8"	25 cm, 10"	30 cm, 12"

¼	¼	¼
09-266-20	09-266-25	09-266-30
09-268-20	09-268-25	09-268-30
20 cm, 8"	25 cm, 10"	30 cm, 12"

Standard patterns
 Standard modelle
 Modelos standard
 Modèles standard
 Modelli standard

Narrow Patterns
 Schmale Modelle
 Modelos estrechos
 Modèles étroits
 Modelli stretti



09-260-10
 09-260-30

MOD-USA
 09-262-10
 09-262-30

09-266-10
 09-266-30

MOD-USA
 09-268-10
 09-268-30

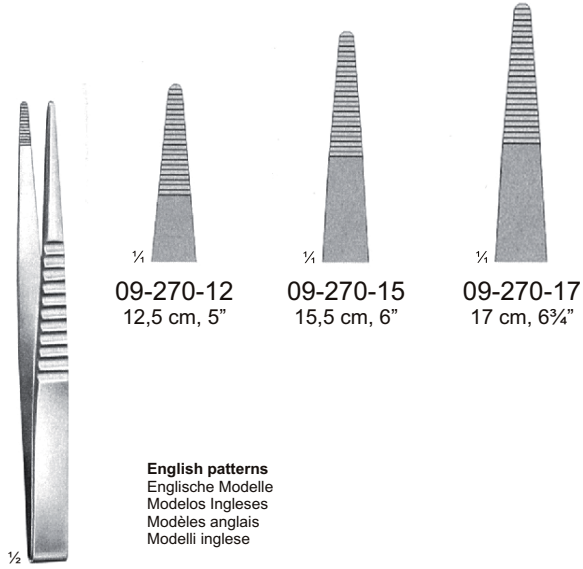

09-270-12
12,5 cm, 5"

09-270-15
15,5 cm, 6"

09-270-17
17 cm, 6¾"

English patterns
 Englische Modelle
 Modelos Ingleses
 Modèles anglais
 Modelli inglese

09-270-12
09-270-17

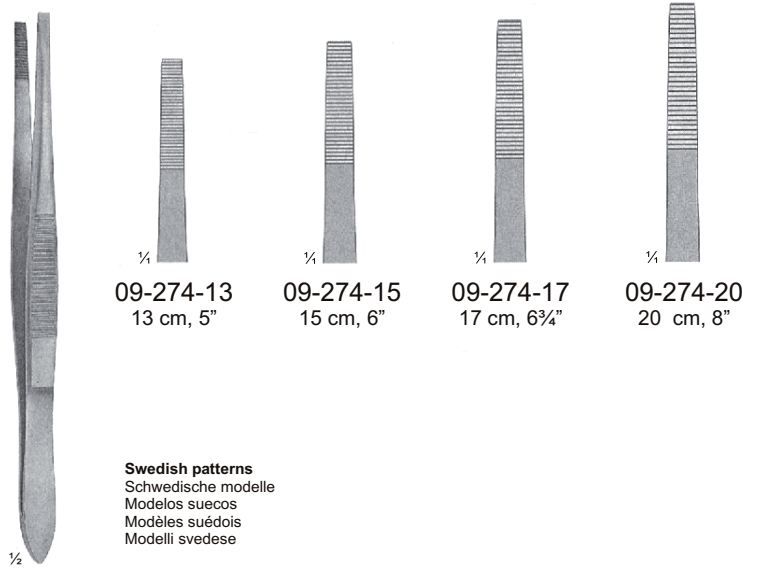

09-274-13
13 cm, 5"

09-274-15
15 cm, 6"

09-274-17
17 cm, 6¾"

09-274-20
20 cm, 8"

Swedish patterns
 Schwedische modelle
 Modelos suecos
 Modèles suédois
 Modelli svedese

09-274-13
09-274-20

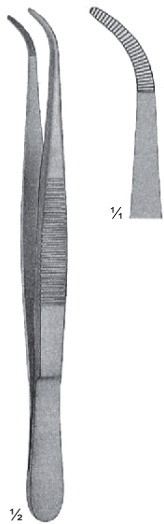

09-277-14
14 cm, 5½"

Narrow Patterns
 Schmale Modelle
 Modelos estrechos
 modés étroits
 modelli stretti

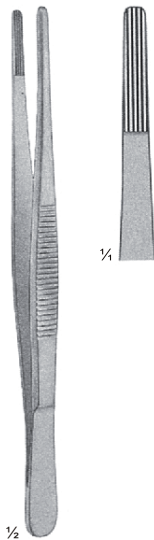

OCHSNER
 09-280-14
14,5 cm, 5¾"

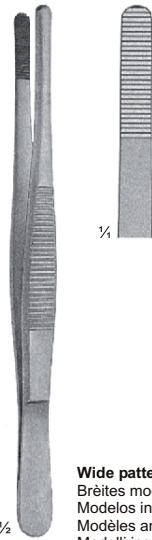

09-284-14
14,5 cm, 5¾"

Wide patterns
 Brèites modelle
 Modelos ingleses
 Modèles anglais
 Modelli inglese



ARMSEY
 09-288-18
18 cm, 7"

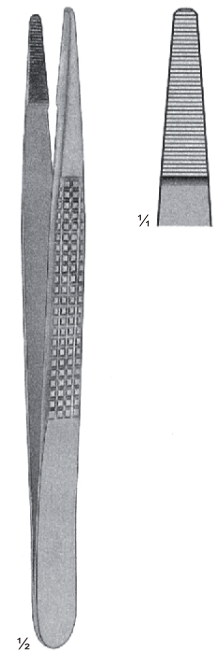

BONNEY
 09-290-17
17 cm, 6¾"

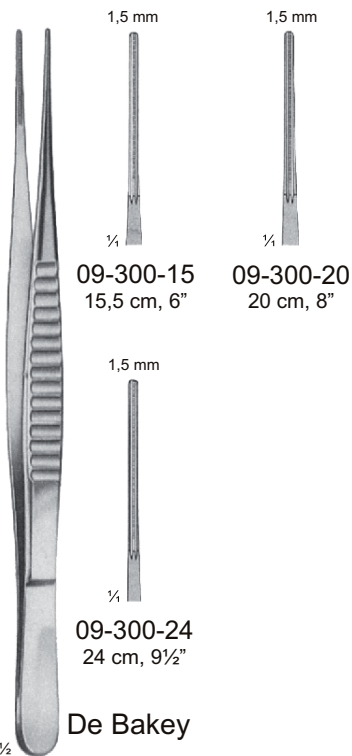

09-300-15
09-300-24

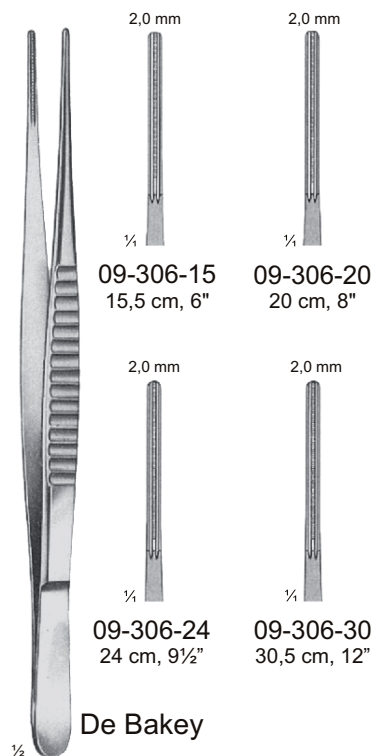

09-306-15
09-306-30

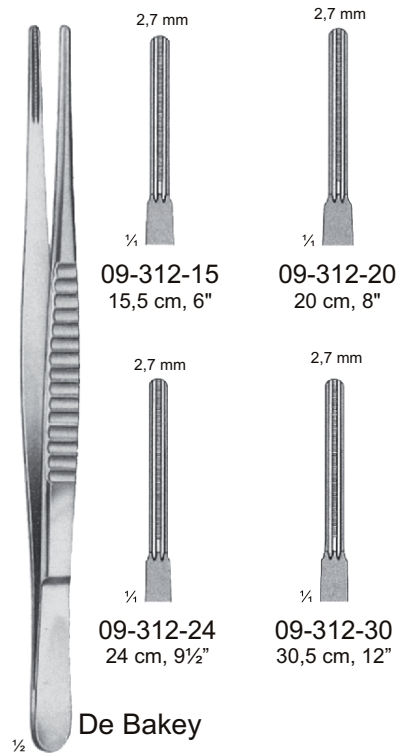

09-312-15
09-312-30

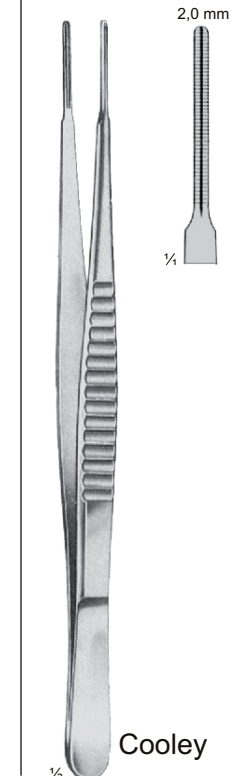

09-316-16 16 cm, 6¼"
09-316-20 20 cm, 8"

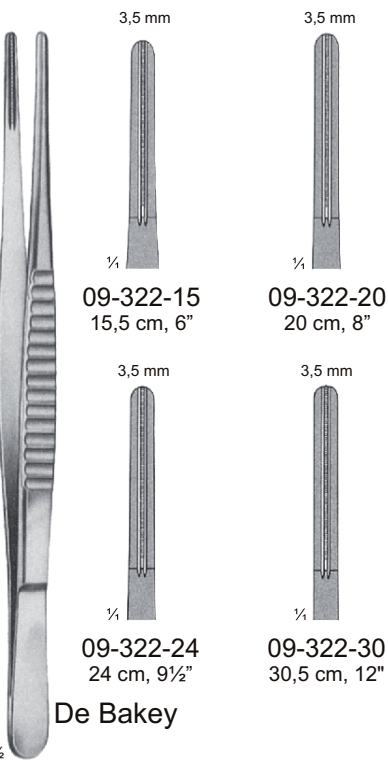

09-322-15
09-322-30

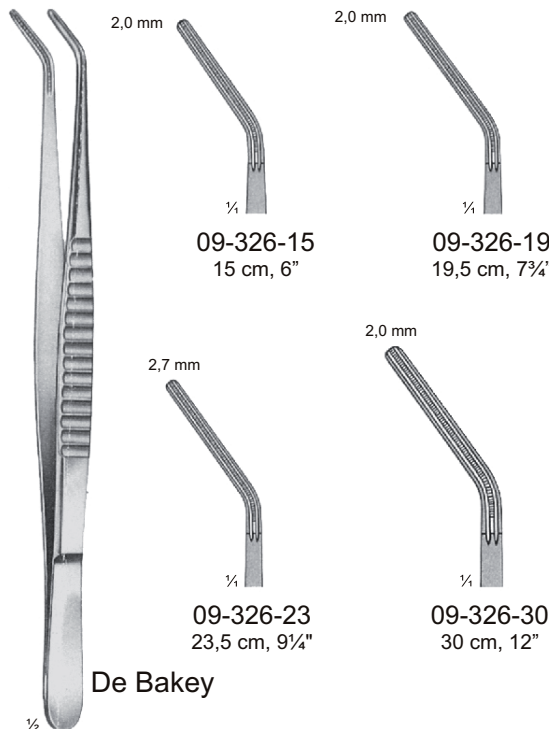



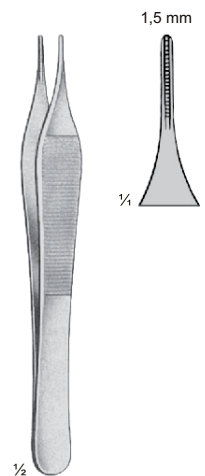



09-326-15
09-326-30



09-330-12 12 cm, 4¾"
09-330-15 15 cm, 6"



 1,5 mm ¼ 09-302-15 15,5 cm, 6" 1,5 mm ¼ 09-302-20 20 cm, 8" 1,5 mm ¼ 09-302-24 24 cm, 9½" De Bakey ½ 09-302-15 09-302-24 ■ Titanium	 2,0 mm ¼ 09-308-15 15,5 cm, 6" 2,0 mm ¼ 09-308-20 20 cm, 8" 2,0 mm ¼ 09-308-24 24 cm, 9½" 2,0 mm ¼ 09-308-30 30,5 cm, 12" De Bakey ½ 09-308-15 09-308-30 ■ Titanium	 2,7 mm ¼ 09-314-15 15,5 cm, 6" 2,7 mm ¼ 09-314-20 20 cm, 8" 2,7 mm ¼ 09-314-24 24 cm, 9½" 2,7 mm ¼ 09-314-30 30,5 cm, 12" De Bakey ½ 09-314-15 09-314-30 ■ Titanium	 2,0 mm ¼ 09-318-16 16 cm, 6¼" 2,0 mm ¼ 09-318-20 20 cm, 8" Cooley ½ 09-318-16 09-318-20 ■ Titanium
---	---	---	--

 3,5 mm ¼ 09-324-15 15,5 cm, 6" 3,5 mm ¼ 09-324-20 20 cm, 8" 3,5 mm ¼ 09-324-24 24 cm, 9½" 3,5 mm ¼ 09-324-30 30,5 cm, 12" De Bakey ½ 09-324-15 09-324-30 ■ Titanium	 2,0 mm ¼ 09-328-15 15 cm, 6" 2,0 mm ¼ 09-328-19 19,5 cm, 7¾" 2,7 mm ¼ 09-328-23 23,5 cm, 9¼" 2,0 mm ¼ 09-328-30 30 cm, 12" De Bakey ½ 09-328-15 09-328-30 ■ Titanium	 1,5 mm ¼ 09-332-12 12 cm, 4¾" 09-332-15 15 cm, 6" ADSON ½ 09-332-12 09-332-15 ■ Titanium
---	---	---



LUCAE
 09-340-14
 14 cm, 5½"



JANSEN
 09-342-16
 16 cm, 6¼"
 09-342-20
 20 cm, 8"



GRUENWALD
 09-348-20
 20 cm, 8"



**TAYLOR
 CUSHING**
 09-350-18
 18 cm, 7"

With dissector end
 Mit dissektor-ende
 Con cabo disecador
 Avec talon dissecteur
 Con dissettore

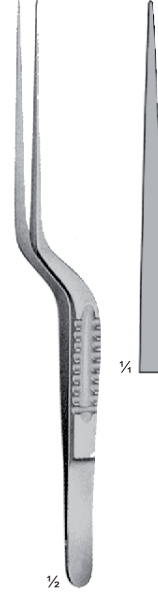

09-356-16
 16 cm, 6¼"

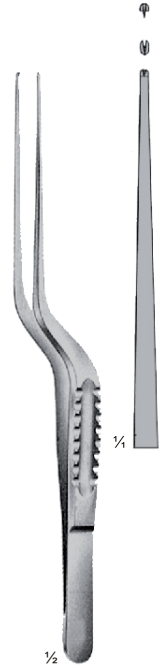

09-357-16
 16 cm, 6¼"

1x2 Teeth
 1x2 Zähne
 1x2 Dientes
 1x2 Dents
 1x2 Denti

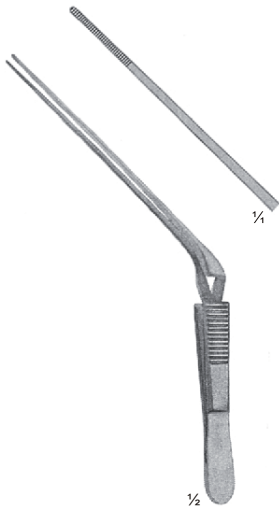

**TROELTSCH
 (WILDE)**
 09-362-13
 13 cm, 5"

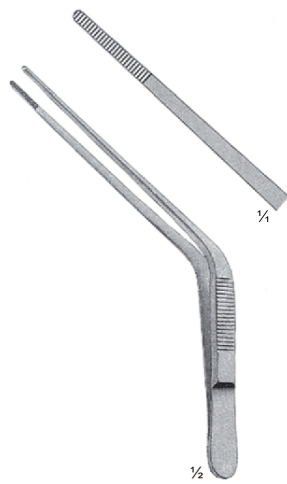

**TROELTSCH
 (WILDE)**
 09-366-11
 11 cm, 4.5"
 09-366-12
 12 cm, 4¾"

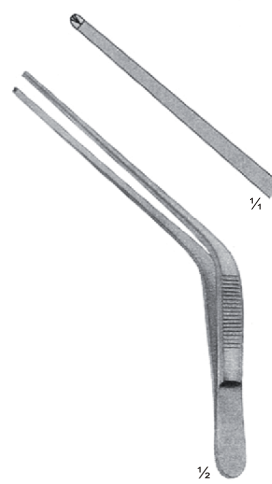

TROELTSCH
 09-367-15
 15 cm, 6"

1x2 Teeth
 1x2 Zähne
 1x2 Dientes
 1x2 Dents
 1x2 Denti

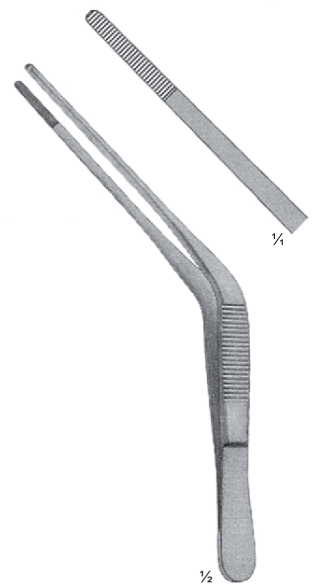

TROELTSCH
 09-370-18
 18 cm, 7"

1x2 Teeth
 1x2 Zähne
 1x2 Dientes
 1x2 Dents
 1x2 Denti

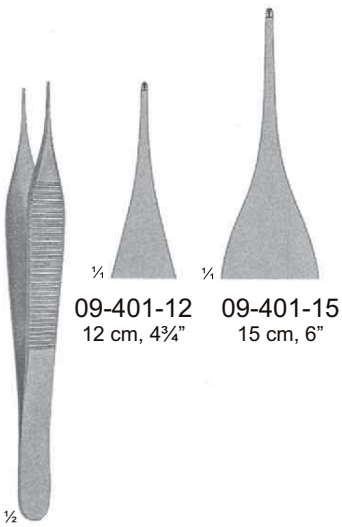

**MICRO
ADSON**
 09-401-12
 09-401-15

1x2 Teeth
 1x2 Zähne
 1x2 Dientes
 1x2 Dents
 1x2 Dentì

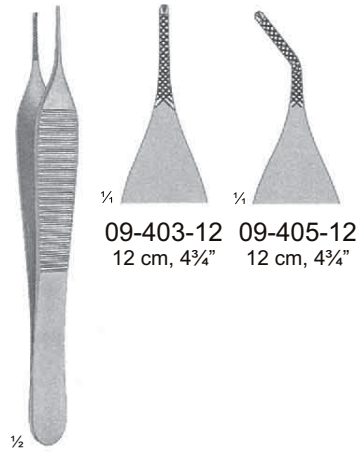

MINI ADSON
 09-403-12
 09-405-12

1x2 Teeth
 1x2 Zähne
 1x2 Dientes
 1x2 Dents
 1x2 Dentì

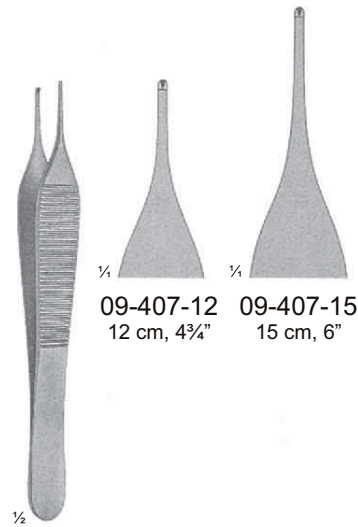

ADSON
 09-407-12
 09-407-15

1x2 Teeth
 1x2 Zähne
 1x2 Dientes
 1x2 Dents
 1x2 Dentì

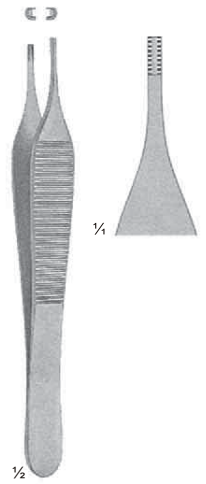

**ADSON
BROWN**
 09-409-12
 12 cm, 4 3/4"

9x9 Teeth
 9x9 Zähne
 9x9 Dientes
 9x9 Dents
 9x9 Dentì

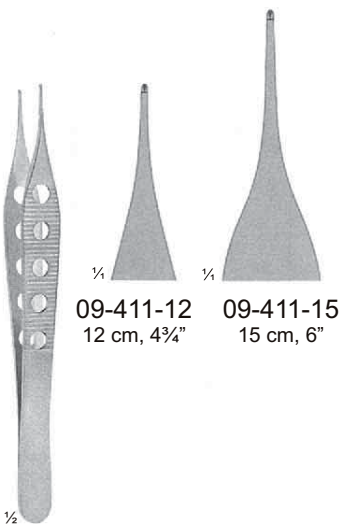

**MICRO
ADSON**
 09-411-12
 09-411-15

1x2 Teeth
 1x2 Zähne
 1x2 Dientes
 1x2 Dents
 1x2 Dentì

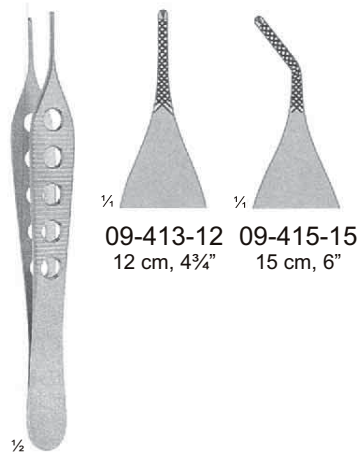

ADSON
 09-413-12
 09-415-15

1x2 Teeth
 1x2 Zähne
 1x2 Dientes
 1x2 Dents
 1x2 Dentì

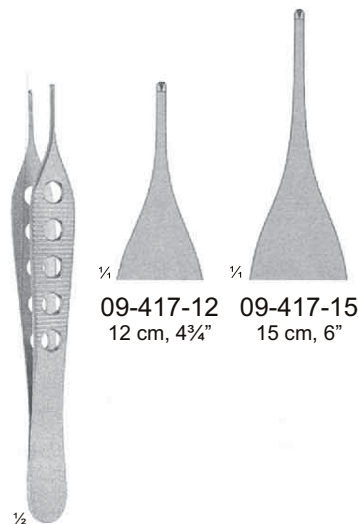

ADSON
 09-417-12
 09-417-15

1x2 Teeth
 1x2 Zähne
 1x2 Dientes
 1x2 Dents
 1x2 Dentì

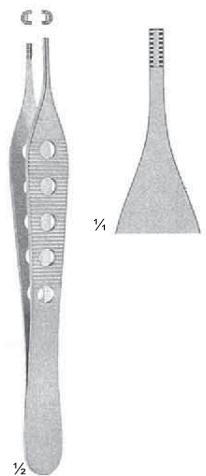

**ADSON
BROWN**
 09-419-12
 12 cm, 4 3/4"

9x9 Teeth
 9x9 Zähne
 9x9 Dientes
 9x9 Dents
 9x9 Dentì



09-426-12
12,5 cm, 5"

¼

09-426-15
15 cm, 6"

¼

SEMKEN 1x2 Teeth
 09-426-12 1x2 Zähne
 09-426-15 1x2 Dientes
 1x2 Dents
 1x2 Denti



¼

CUSHING 1x2 Teeth
 09-433-17 1x2 Zähne
 17 cm, 6¾" 1x2 Dientes
 1x2 Dents
 1x2 Denti



¼

TAYLOR CUSHING 1x2 Teeth
 09-435-17 1x2 Zähne
 17,5 cm, 7" 1x2 Dientes
 1x2 Dents
 1x2 Denti



09-437-18
18 cm, 7"

¼

09-437-21
21 cm, 8¼"

¼

09-437-25
25 cm, 10"

¼

09-437-30
30,5 cm, 12"

¼

POTTS-SMITH 1x2 Teeth
 09-437-18 1x2 Zähne
 09-437-30 1x2 Dientes
 1x2 Dents
 1x2 Denti



¼

WAUGH 1x2 Teeth
 09-439-20 1x2 Zähne
 20,5 cm, 8" 1x2 Dientes
 1x2 Dents
 1x2 Denti

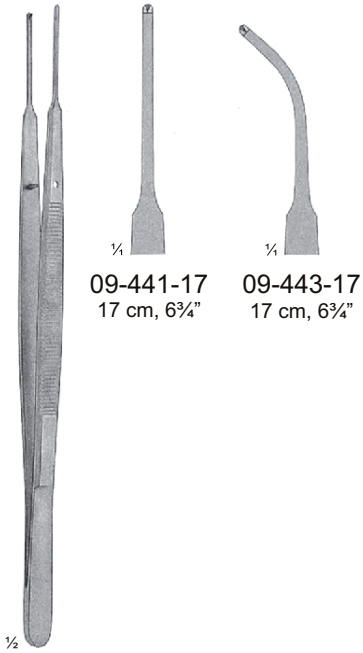

09-441-17
17 cm, 6¾"

09-443-17
17 cm, 6¾"

GERALD
09-441-17
09-443-17

1x2 Teeth
1x2 Zähne
1x2 Dientes
1x2 Dents
1x2 Denti

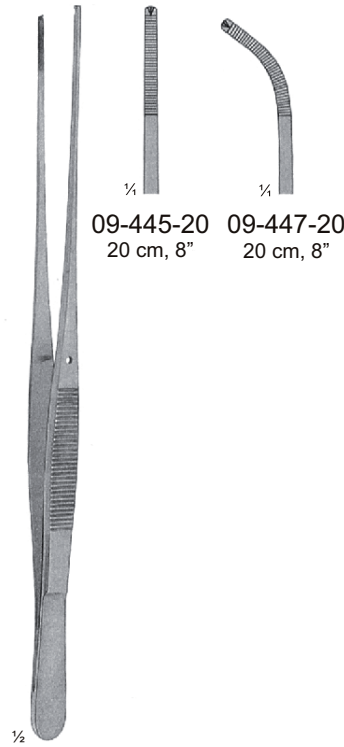

09-445-20
20 cm, 8"

09-447-20
20 cm, 8"

BROPHY
09-445-20
09-447-20

1x2 Teeth
1x2 Zähne
1x2 Dientes
1x2 Dents
1x2 Denti



GILLIES
09-449-15
15 cm, 6"

1x2 Teeth
1x2 Zähne
1x2 Dientes
1x2 Dents
1x2 Denti

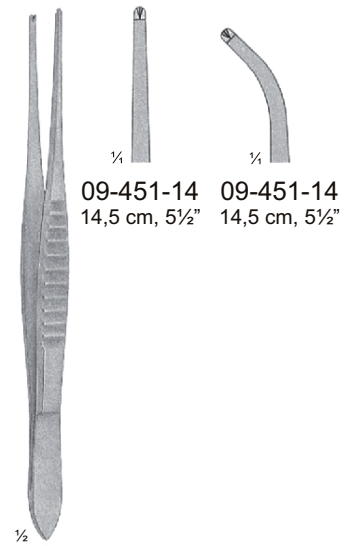

09-451-14
14,5 cm, 5½"

09-451-14
14,5 cm, 5½"

MOD-USA
09-451-14
09-451-14

1x2 Teeth
1x2 Zähne
1x2 Dientes
1x2 Dents
1x2 Denti

Narrow Patterns
Schmale Modelle
Modeios estrechos
modès étroits
modelli stretti



09-455-01
09-455-06

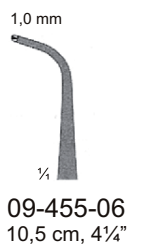
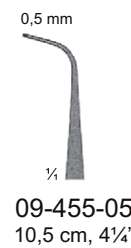
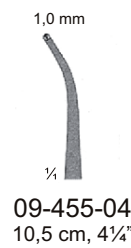
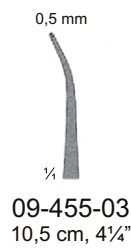
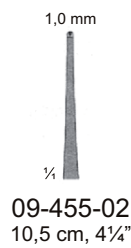
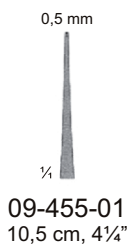

1x2 Teeth
1x2 Zähne
1x2 Dientes
1x2 Dents
1x2 Denti



Tissue Forceps
 Chirurgische pinzetten
 Pinzas quirúrgicas
 Pincas chirurgicales
 Pinze per chirurgia



09



09-461-10	09-461-12	09-461-13
09-463-10	09-463-12	09-463-13
10,5 cm, 4 1/8"	12 cm, 4 3/4"	13 cm, 5"

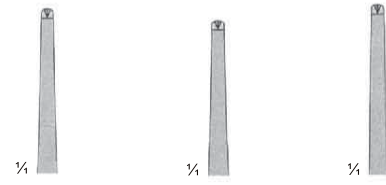

09-467-10	09-467-12	09-467-13
09-469-10	09-469-12	09-469-13
10,5 cm, 4 1/8"	12 cm, 4 3/4"	13 cm, 5"

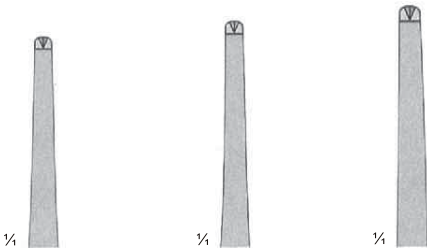

09-461-14	09-461-16	09-461-18
09-463-14	09-463-16	09-463-18
14,5 cm, 5 1/2"	16 cm, 6 1/4"	18,5 cm, 7 1/4"

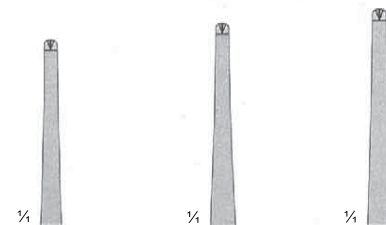

09-467-14	09-467-16	09-467-18
09-469-14	09-469-16	09-469-18
14,5 cm, 5 1/2"	16 cm, 6 1/4"	18,5 cm, 7 1/4"

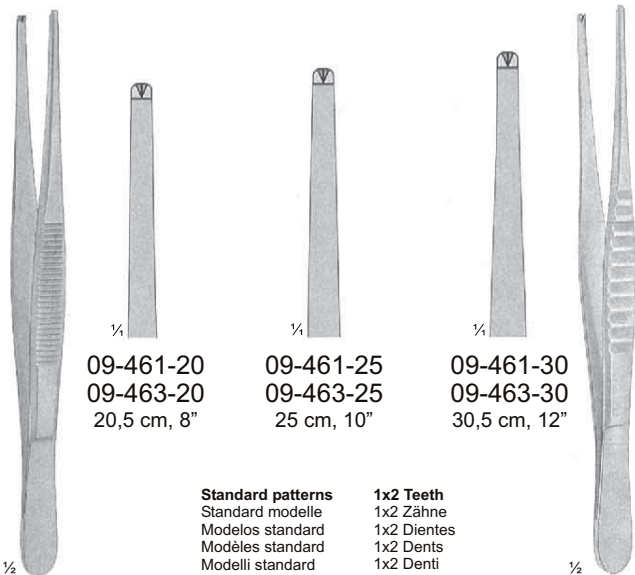

09-461-20	09-461-25	09-461-30
09-463-20	09-463-25	09-463-30
20,5 cm, 8"	25 cm, 10"	30,5 cm, 12"

Standard patterns
 Standard modelle
 Modelos standard
 Modèles standard
 Modelli standard

1x2 Teeth
 1x2 Zähne
 1x2 Dientes
 1x2 Dents
 1x2 Denti

MOD-USA

09-461-10	09-463-10
09-461-30	09-463-30

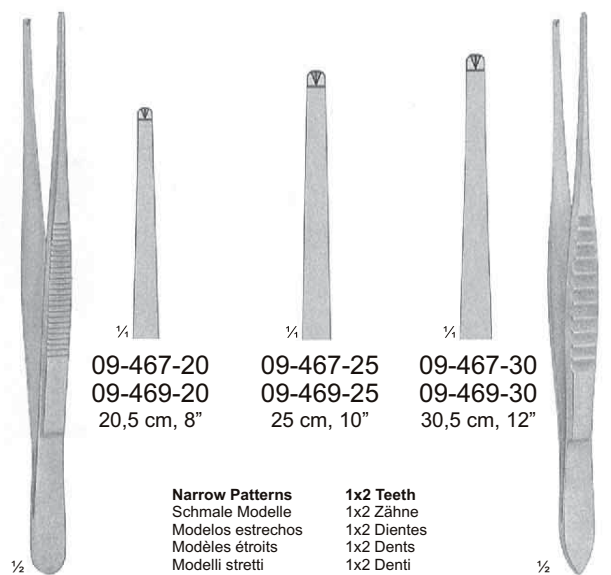

09-467-20	09-467-25	09-467-30
09-469-20	09-469-25	09-469-30
20,5 cm, 8"	25 cm, 10"	30,5 cm, 12"

Narrow Patterns
 Schmale Modelle
 Modelos estrechos
 Modèles étroits
 Modelli stretti

1x2 Teeth
 1x2 Zähne
 1x2 Dientes
 1x2 Dents
 1x2 Denti

MOD-USA

09-467-10	09-469-10
09-467-30	09-469-30



09-481-13
13 cm, 5 1/8"



09-481-14
14,5 cm, 5 3/4"



09-481-16
16 cm, 6 1/4"



09-481-18
18 cm, 7"



09-481-20
20 cm, 8"



09-481-25
25 cm, 10"



2x3 Teeth
 2x3 Zähne
 2x3 Dientes
 2x3 Dents
 2x3 Denti

09-481-13
09-481-25



09-485-14
09-485-20



09-485-14
14,5 cm, 5 3/4"



09-485-16
16 cm, 6 1/4"



09-485-20
20 cm, 8"

3x4 Teeth
 3x4 Zähne
 3x4 Dientes
 3x4 Dents
 3x4 Denti



09-485-14
09-485-20



09-487-14
14,5 cm, 5 3/4"



4x5 Teeth
 4x5 Zähne
 4x5 Dientes
 4x5 Dents
 4x5 Denti



09-489-14
14 cm, 5 1/2"



1x2 Teeth
 1x2 Zähne
 1x2 Dientes
 1x2 Dents
 1x2 Denti

Narrow Pattern
 Schmales Modell
 Modelo estrecho
 Modèle étroit
 Modello stretto

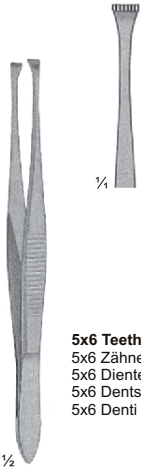

GRAEFE
 09-501-11
 11 cm, 4 $\frac{3}{4}$ "

5x6 Teeth
 5x6 Zähne
 5x6 Dientes
 5x6 Dents
 5x6 Denti



LANE
 09-507-14 14 cm, 5 $\frac{3}{4}$ "
 09-507-20 20 cm, 8"

1x2 Teeth
 1x2 Zähne
 1x2 Dientes
 1x2 Dents
 1x2 Denti



LANE
 09-509-14 14 cm, 5 $\frac{3}{4}$ "
 09-509-20 20 cm, 8"

2x3 Teeth
 2x3 Zähne
 2x3 Dientes
 2x3 Dents
 2x3 Denti



BROWN
 09-511-15
 09-511-25

Tissue seizing forceps
 GewebefalSpinzetten
 Pinzas agarre de tejidos
 Pincas pour saisir les tissus
 Pinze da presa per tessuti

09-511-15
 15 cm, 6"

09-511-20
 20 cm, 8"

09-511-25
 25 cm, 10"



BONNEY
 09-521-18
 09-523-18

1x2 Teeth
 1x2 Zähne
 1x2 Dientes
 1x2 Dents
 1x2 Denti

09-521-18
 18 cm, 7"

09-523-18
 18 cm, 7"

2x3 Teeth
 2x3 Zähne
 2x3 Dientes
 2x3 Dents
 2x3 Denti



FERRIS-SMITH
 09-527-18
 09-529-18

1x2 Teeth
 1x2 Zähne
 1x2 Dientes
 1x2 Dents
 1x2 Denti

09-527-18
 18 cm, 7"

09-529-18
 18 cm, 7"



ADLERKREUTZ
 09-541-14
 09-541-24

Vascular and tumor forceps
 Gefäß- und Tumorpinzetten
 Pinzas para vasos y tumores
 Pincas pour vaisseaux et tumeurs
 Pinza vascolare e per tumori

09-541-14
 14,5 cm, 5 $\frac{3}{4}$ "

09-541-20
 20 cm, 8"

09-541-24
 24,5 cm, 8"

4x5 Teeth
 4x5 Zähne
 4x5 Dientes
 4x5 Dents
 4x5 Denti

4x5 Teeth
 4x5 Zähne
 4x5 Dientes
 4x5 Dents
 4x5 Denti

6x7 Teeth
 6x7 Zähne
 6x7 Dientes
 6x7 Dents
 6x7 Denti

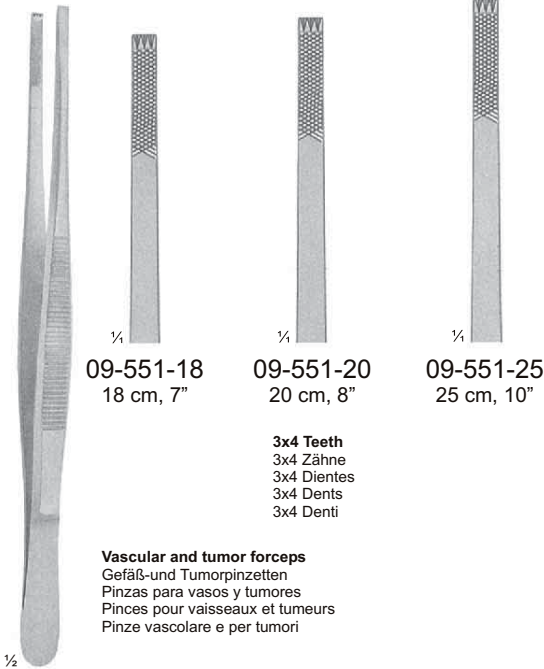

09-551-18
18 cm, 7"

09-551-20
20 cm, 8"

09-551-25
25 cm, 10"

3x4 Teeth
 3x4 Zähne
 3x4 Dientes
 3x4 Dents
 3x4 Denti

Vascular and tumor forceps
 Gefäß- und Tumorpinzetten
 Pinzas para vasos y tumores
 Pincas pour vaisseaux et tumeurs
 Pinze vascolare e per tumori

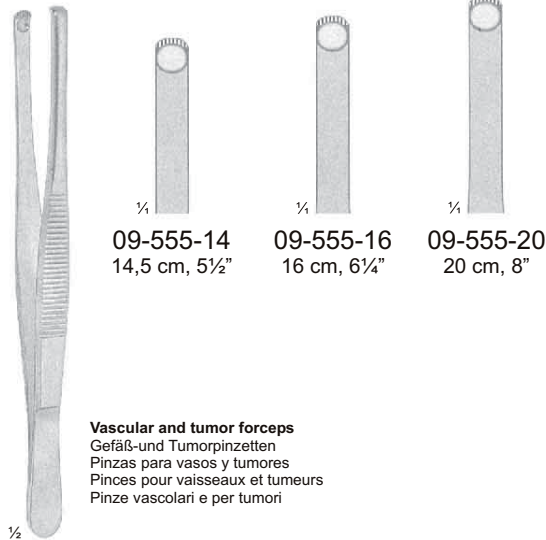

09-555-14
14,5 cm, 5½"

09-555-16
16 cm, 6¼"

09-555-20
20 cm, 8"

Vascular and tumor forceps
 Gefäß- und Tumorpinzetten
 Pinzas para vasos y tumores
 Pincas pour vaisseaux et tumeurs
 Pinze vascolari e per tumori

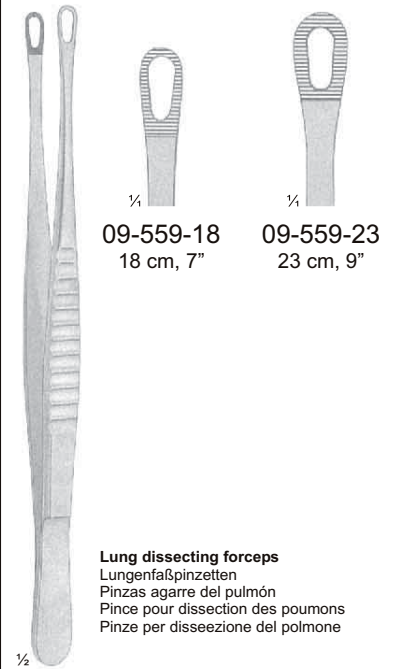

09-559-18
18 cm, 7"

09-559-23
23 cm, 9"

Lung dissecting forceps
 Lungenfaßpinzetten
 Pinzas agarre del pulmón
 Pince pour dissection des pommans
 Pinze per dissezione del polmone

STILLE
 09-551-18
 09-551-25

DURANTE
 09-555-14
 09-555-20

SINGLEY-TUTTLE
 09-559-18
 09-559-23

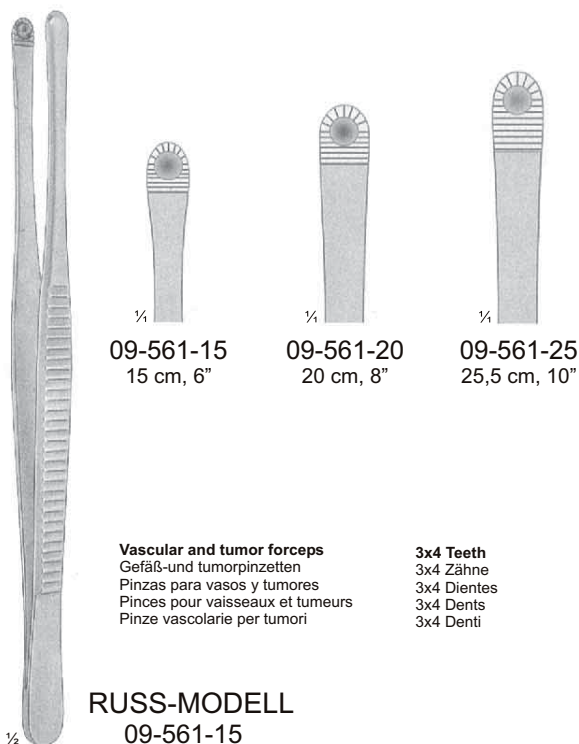

09-561-15
15 cm, 6"

09-561-20
20 cm, 8"

09-561-25
25,5 cm, 10"

Vascular and tumor forceps
 Gefäß- und tumorpinzetten
 Pinzas para vasos y tumores
 Pincas pour vaisseaux et tumeurs
 Pinze vascolare per tumori

3x4 Teeth
 3x4 Zähne
 3x4 Dientes
 3x4 Dents
 3x4 Denti

RUSS-MODELL
 09-561-15
 09-561-25

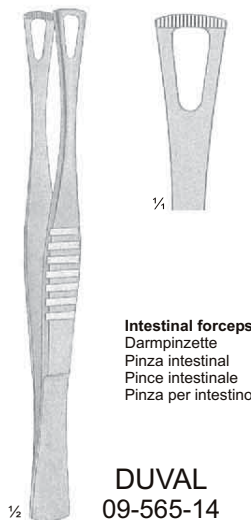

DUVAL
 09-565-14
 14 cm, 5½"

Intestinal forceps
 Darmpinzette
 Pinza intestinal
 Pince intestinale
 Pinza per intestino

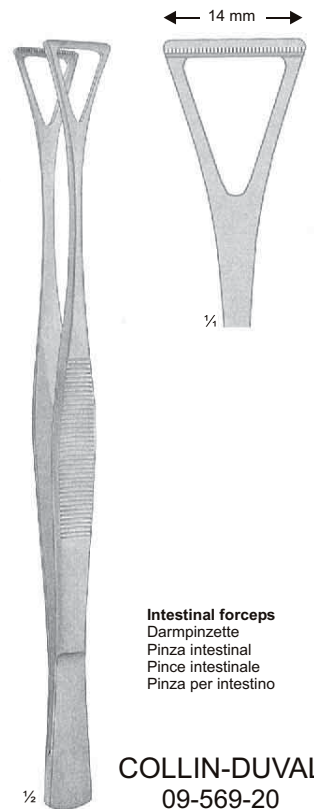

COLLIN-DUVAL
 09-569-20
 20 cm, 8"

Intestinal forceps
 Darmpinzette
 Pinza intestinal
 Pince intestinale
 Pinza per intestino



Splinter Forceps
 Splitterpinzetten
 Pinzas para espinas
 Pincas à échardes
 Pinze per schegge



09



09-570-08
8,5 cm, 3³/₄"



09-570-10
10 cm, 4"



09-570-12
12,5 cm, 5"



09-570-14
14 cm, 5¹/₂"



09-570-08
09-571-14



09-571-08
8,5 cm, 3³/₄"



09-571-10
10 cm, 4"



09-571-12
12,5 cm, 5"



09-571-14
14 cm, 5¹/₂"



WALTER-CARMALT
 09-584-10 09-585-10
 10,5 cm, 4¹/₄" 10,5 cm, 4¹/₄"



09-574-10
10,5 cm, 4¹/₄"



09-576-07
7,5 cm, 3"



09-576-09
9 cm, 3¹/₂"

With magnifying loupe
 Mit Lupe
 Con lente de aumento
 Avec loupe
 Con lente di ingrandimento



09-575-10
10,5 cm, 4¹/₄"



FEILCHENFELD
 09-576-08
 09-576-11



09-576-11
11,5 cm, 4¹/₂"

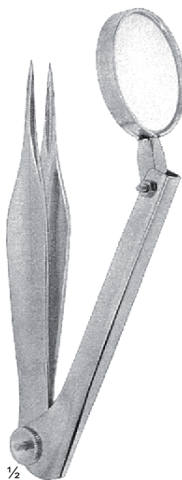

FEILCHENFELD
 09-578-12
 12 cm, 4³/₄"

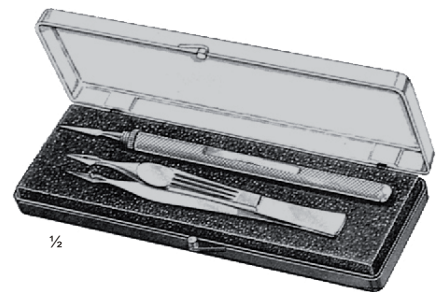

09-588-00

HUNTER
 09-574-10
 09-575-10



09-830-13
 13,5 cm, 5½"

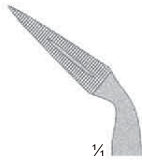

09-831-13
 13,5 cm, 5½"

STIEGLITZ
 09-830-13
 09-831-13

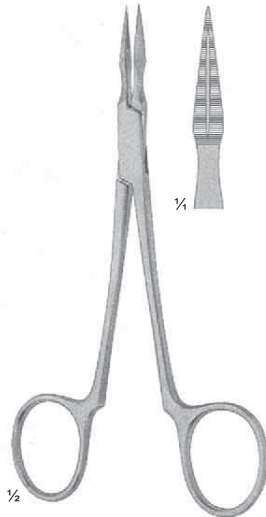

ARTHUR
 09-592-14
 14 cm, 5½"

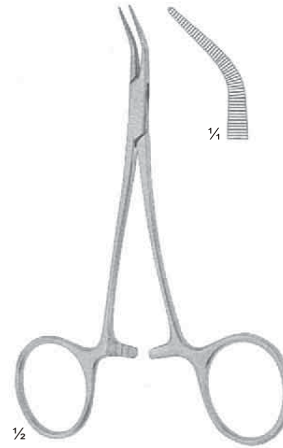

PEET
 09-595-11
 11,5 cm, 4½"

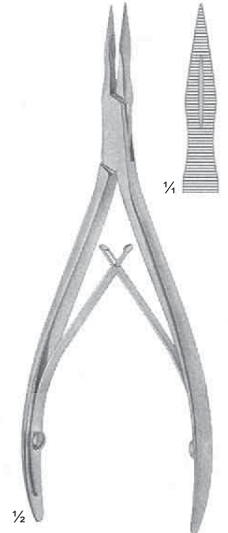

RALKS
 09-598-15
 15 cm, 6"

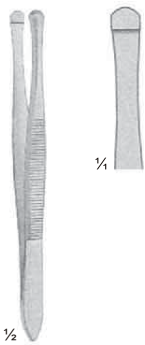

BEER
 09-602-09
 9 cm, 3½"

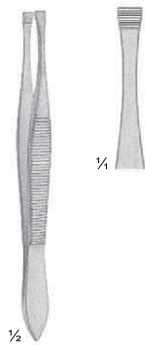

LITTAUER
 09-604-08
 8,5 cm, 3½"

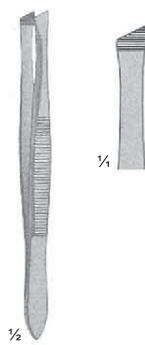

09-606-09
 9 cm, 3½"

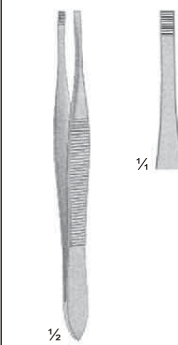

DOUGLAS
 09-608-09
 9 cm, 3½"

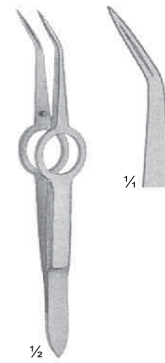

SHAAF
 09-609-09
 9 cm, 3½"

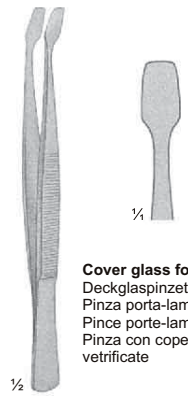

COVER GLASS FORCEPS
 Deckglaspinzette
 Pinza porta-laminilla
 Pince porte-laminaires
 Pinza con copertura
 vetrificate
KUHNE
 09-610-10
 10 cm, 4½"

