

011



Forceps, Clamps Forceps
Klemmen, Klemmzangen
Pinzas, Pinzas-clamps
Pinces, Pinces-clamps
Pinze, Pinze emostatiche



Bulldog Clamps
 Bulldogklemmen
 Clamps Bulldog
 Clamps Bulldog
 Pinze Bulldog



011

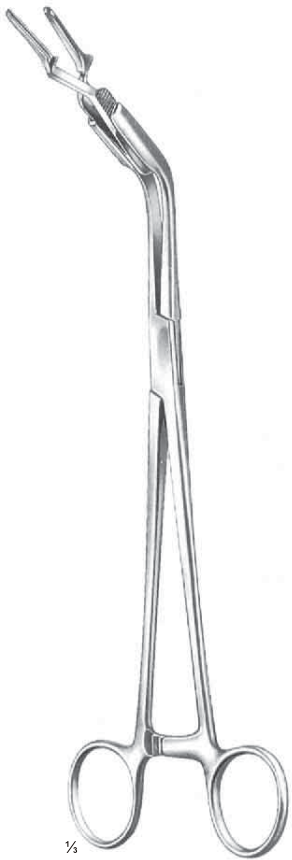

11-110-23
 23 cm, 9"

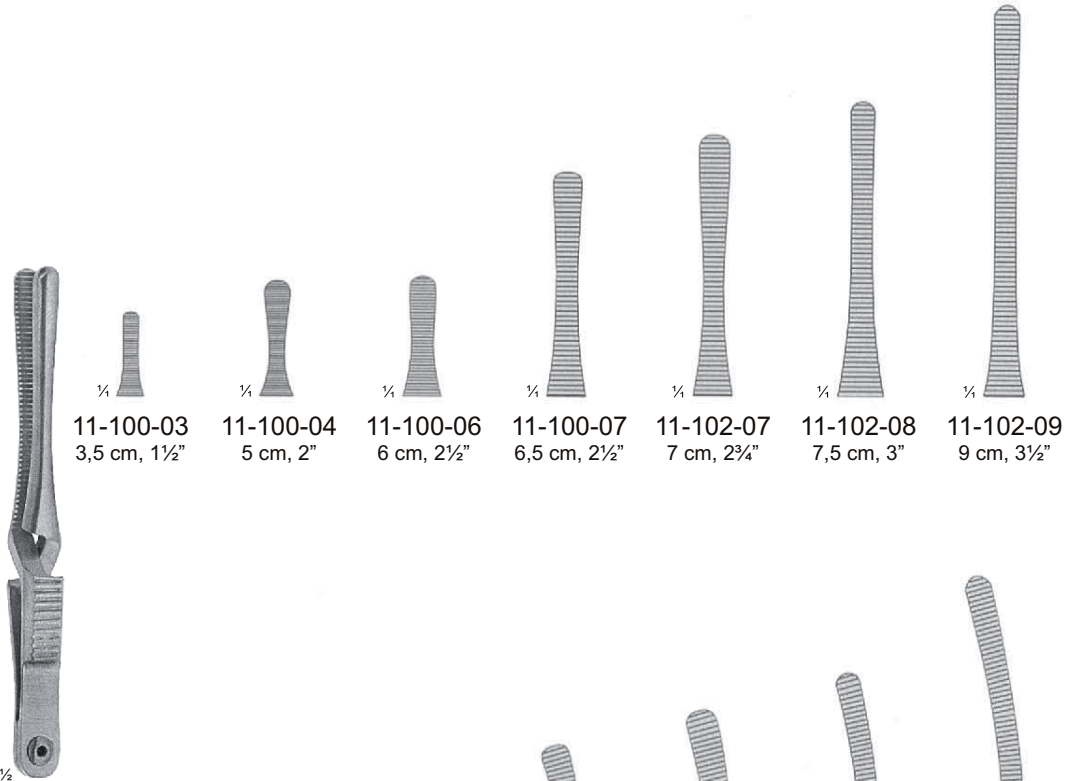

11-100-03 3,5 cm, 1½"
 11-100-04 5 cm, 2"
 11-100-06 6 cm, 2½"
 11-100-07 6,5 cm, 2½"
 11-102-07 7 cm, 2¾"
 11-102-08 7,5 cm, 3"
 11-102-09 9 cm, 3½"

JOHNS HOPKINS
 11-100-03
 11-103-09

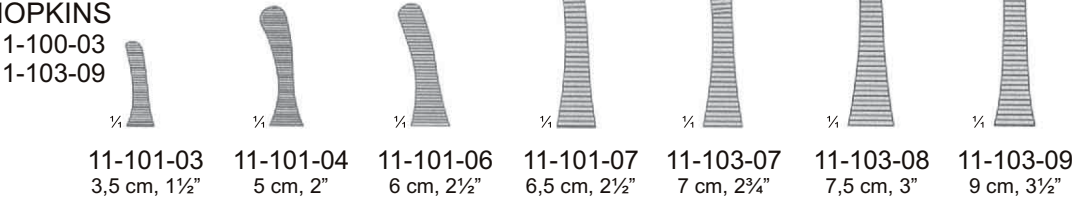

11-101-03 3,5 cm, 1½"
 11-101-04 5 cm, 2"
 11-101-06 6 cm, 2½"
 11-101-07 6,5 cm, 2½"
 11-103-07 7 cm, 2¾"
 11-103-08 7,5 cm, 3"
 11-103-09 9 cm, 3½"

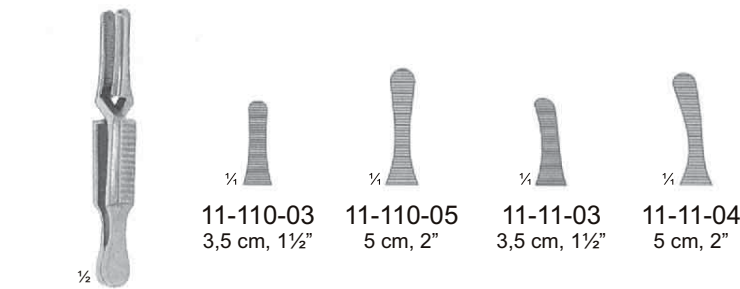

DIEFFENBACH
 11-110-03
 11-111-05

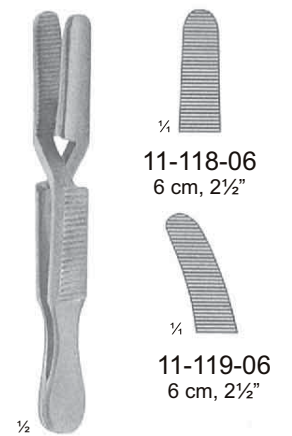

DIEFFENBACH
 11-118-06
 11-119-06

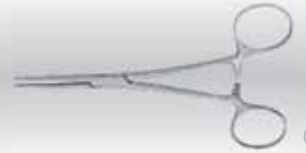

HARTMANN
 11-122-10
 11-125-10

1x2 Teeth
 1x2 Zähne
 1x2 Dientes
 1x2 Dents
 1x2 Denti

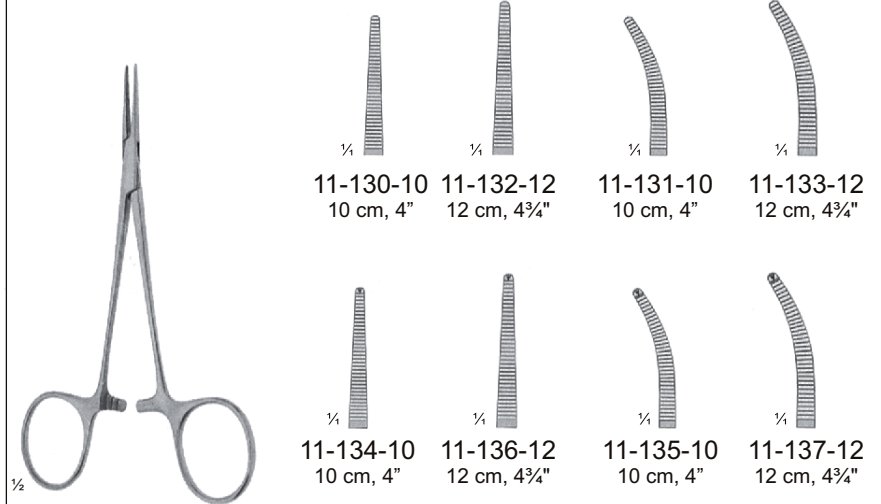

MICRO HALSTED
 11-130-10
 11-137-12

1x2 Teeth
 1x2 Zähne
 1x2 Dientes
 1x2 Dents
 1x2 Denti

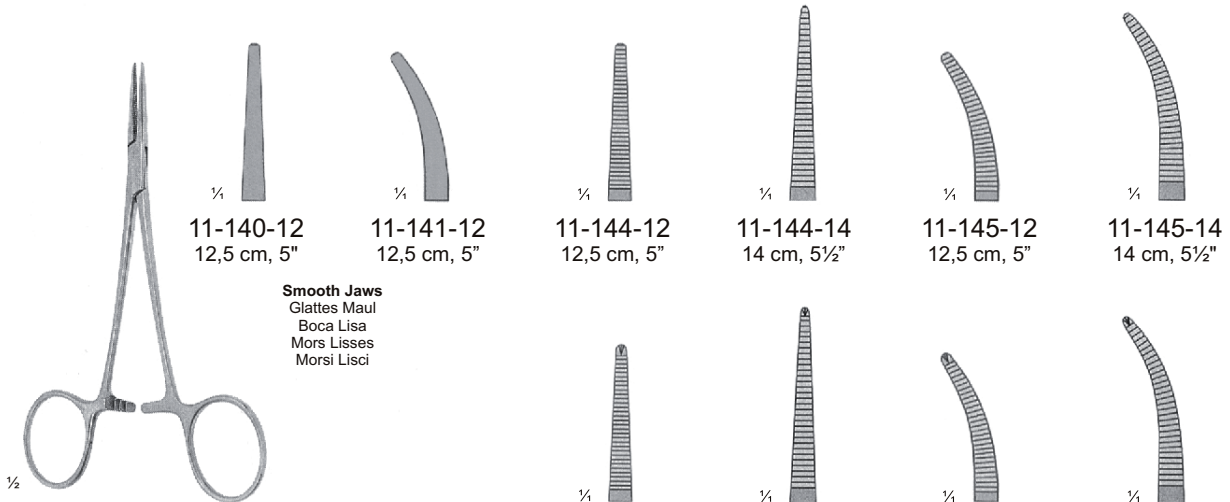

HALSTED MOSQUITO
 11-140-12
 11-147-14

Smooth Jaws
 Glattes Maul
 Boca Lisa
 Mors Lisses
 Morsi Lisci

1x2 Teeth
 1x2 Zähne
 1x2 Dientes
 1x2 Dents
 1x2 Denti

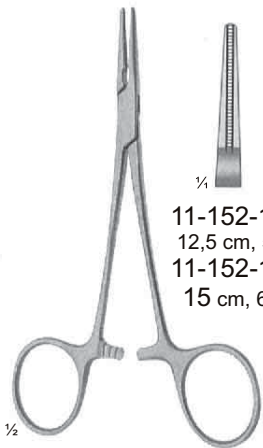

**HALSTED-MOSQUITO
 DE BAKEY**
 11-152-12
 11-153-15

11-152-12 11-153-12
 12,5 cm, 5" 12,5 cm, 5"
 11-152-15 11-153-15
 15 cm, 6" 15 cm, 6"

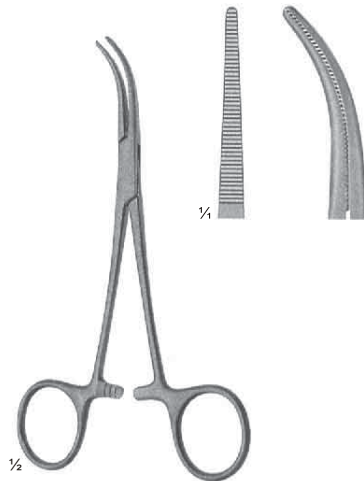

**MOSQUITO
 DANDY**
 11-155-12
 12 cm, 4 3/4"



DANDY
 11-157-14
 11-159-14



11-157-14
 14 cm, 5 1/2"



11-159-14
 14 cm, 5 1/2"

1x2 Teeth
 1x2 Zähne
 1x2 Dientes
 1x2 Dents
 1x2 Denti



BABY-KELLY
 11-162-14
 11-163-14

11-162-14 11-163-14
 14 cm, 5 1/2" 14 cm, 5 1/2"

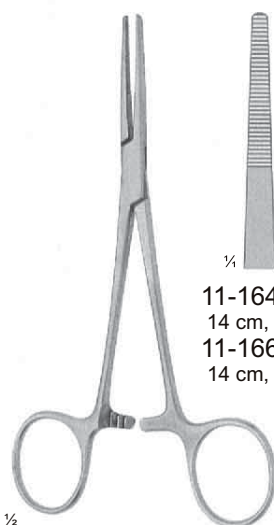

KELLY
 11-164-14
 11-167-14

11-164-14 11-165-14
 14 cm, 5 1/2" 14 cm, 5 1/2"
 11-166-14 11-167-14
 14 cm, 5 1/2" 14 cm, 5 1/2"

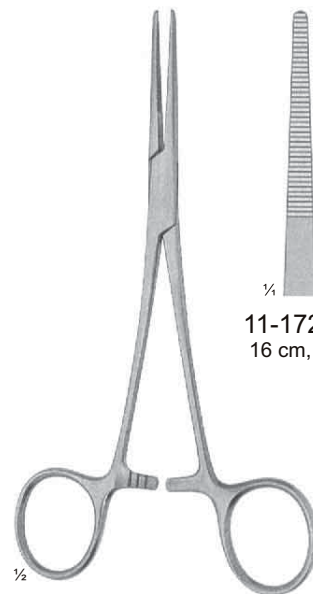

KELLY-RANKIN
 11-172-16
 11-173-16

11-172-16 11-173-16
 16 cm, 6 1/4" 16 cm, 6 1/4"

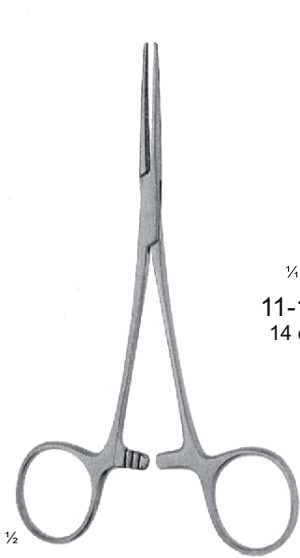
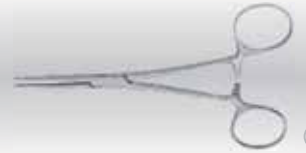

MICRO-CRILE
 11-176-14
 11-177-14

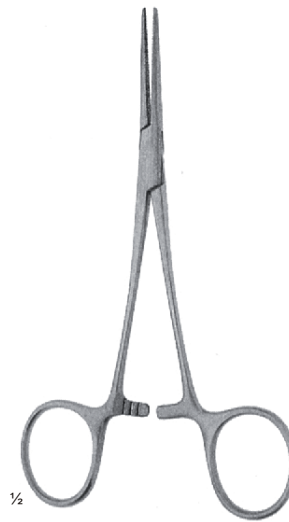
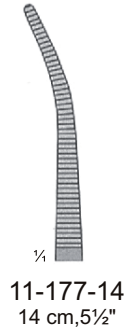
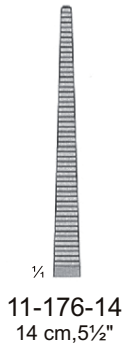

BABY-CRILE
 11-180-14
 11-181-14

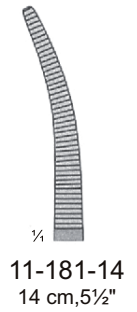
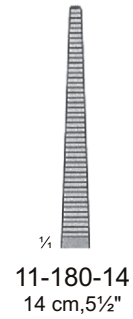

CRILE
 11-184-14
 11-187-14

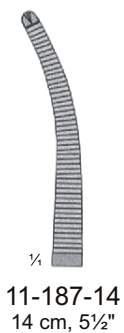
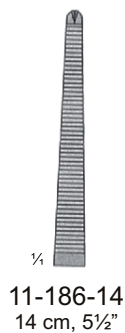
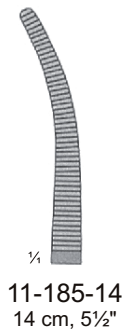
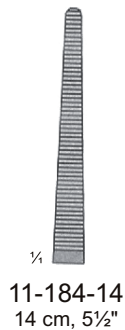

1x2 Teeth
 1x2 Zähne
 1x2 Dientes
 1x2 Dents
 1x2 Denti



CRILE-RANKIN
 11-190-16
 11-193-16

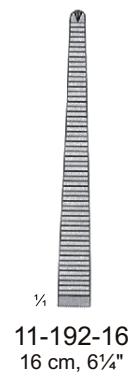
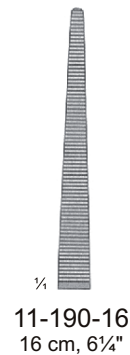

1x2 Teeth
 1x2 Zähne
 1x2 Dientes
 1x2 Dents
 1x2 Denti

Haemostatic Forceps

Arterienklemmen
Pinzas hemostáticas
Pinces hémostatiques
Pinze emostatiche

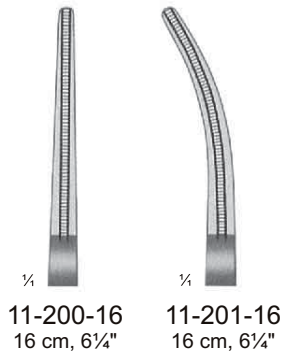

**DE BAKEY
CRILE-RANKIN**
11-200-16
11-201-16

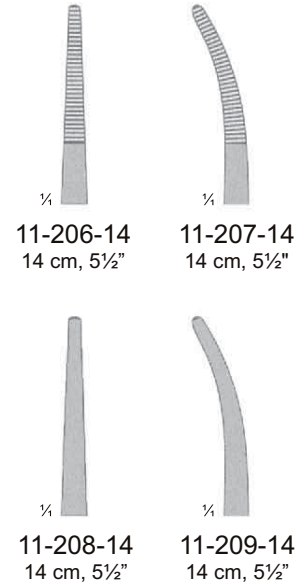
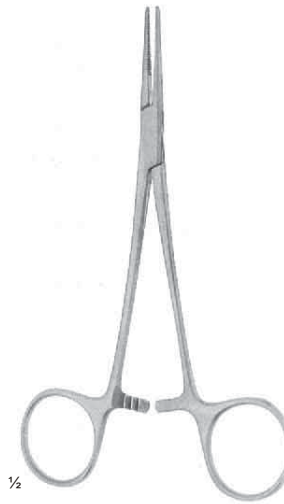

**PROVIDENCE
HOSPITAL**
11-206-14
11-209-14

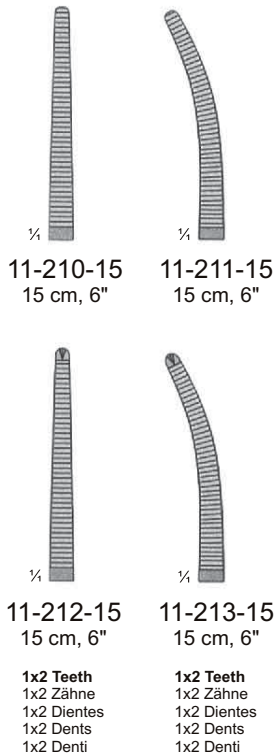

LERICHE
11-210-15
11-213-15

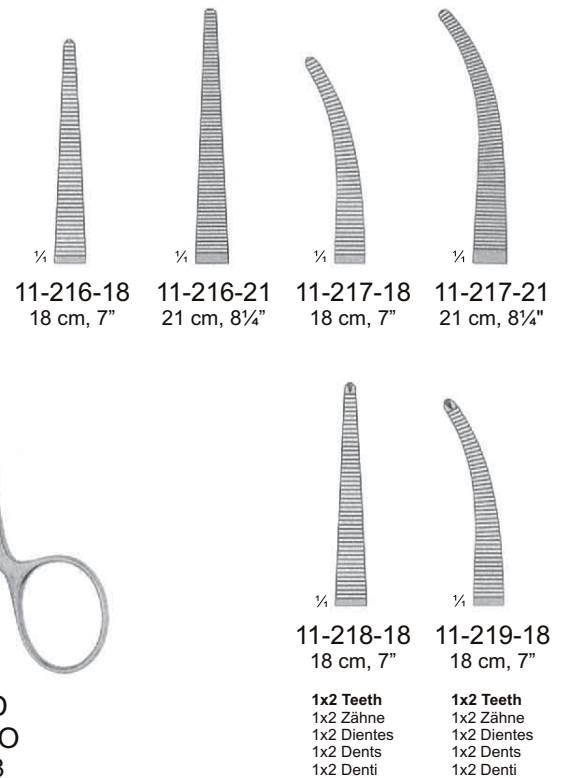
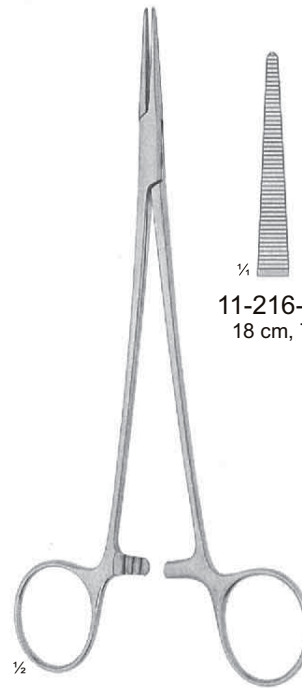

**HALSTED
MOSQUITO**
11-216-18
11-219-18

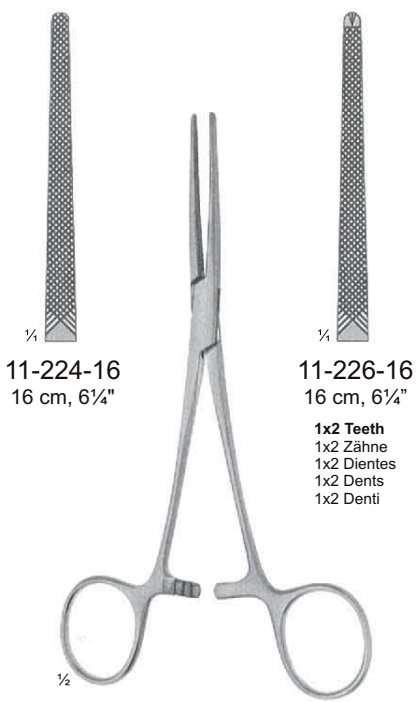
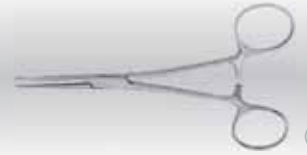

11-224-16
16 cm, 6¼"

11-226-16
16 cm, 6¼"

1x2 Teeth
 1x2 Zähne
 1x2 Dientes
 1x2 Dents
 1x2 Denti

LOVELACE
 11-224-16
 11-226-16

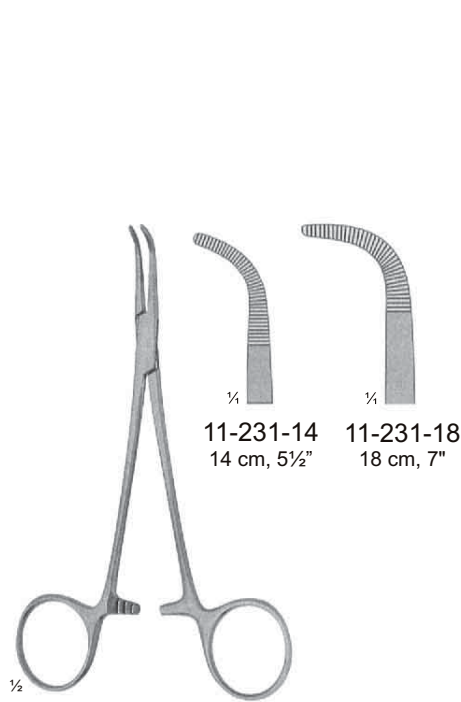

11-231-14
14 cm, 5½"

11-231-18
18 cm, 7"

BABY-ADSON
 11-231-14
 11-231-18

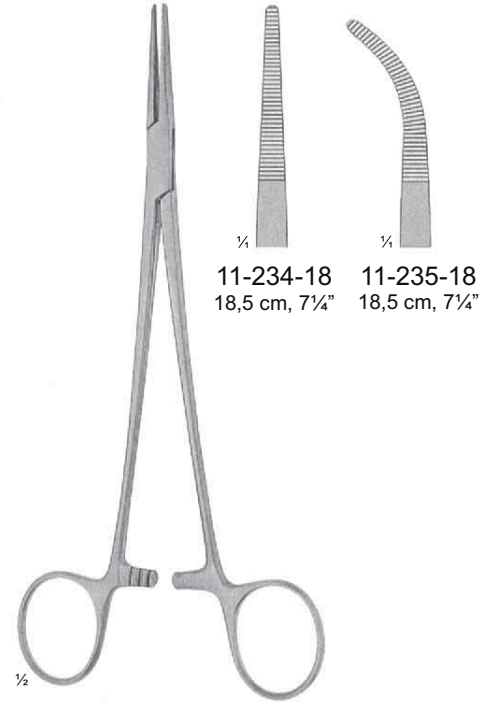

11-234-18
18,5 cm, 7¼"

11-235-18
18,5 cm, 7¼"

ADSON
 11-234-18
 11-235-18

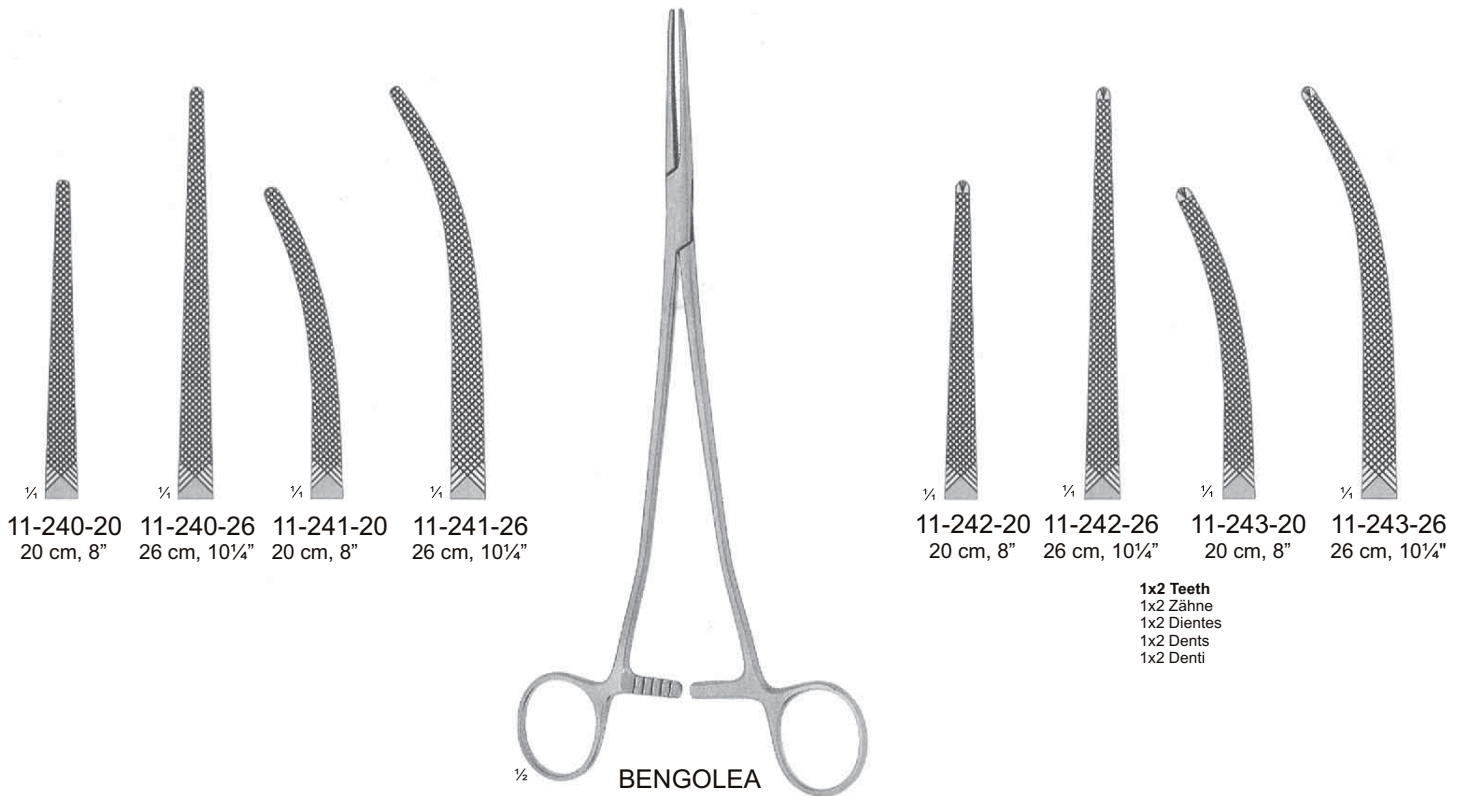

11-240-20
20 cm, 8"

11-240-26
26 cm, 10¼"

11-241-20
20 cm, 8"

11-241-26
26 cm, 10¼"

11-242-20
20 cm, 8"

11-242-26
26 cm, 10¼"

11-243-20
20 cm, 8"

11-243-26
26 cm, 10¼"

1x2 Teeth
 1x2 Zähne
 1x2 Dientes
 1x2 Dents
 1x2 Denti

BENGOLEA
 11-240-20
 11-243-26

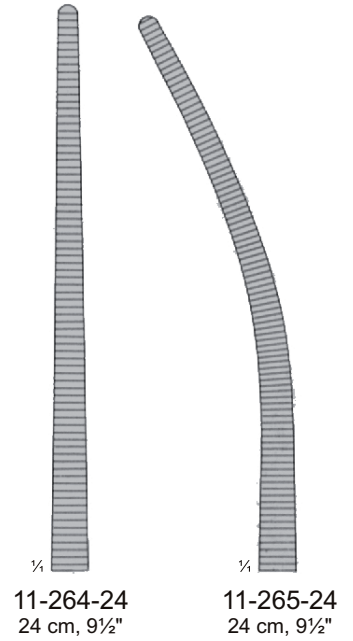
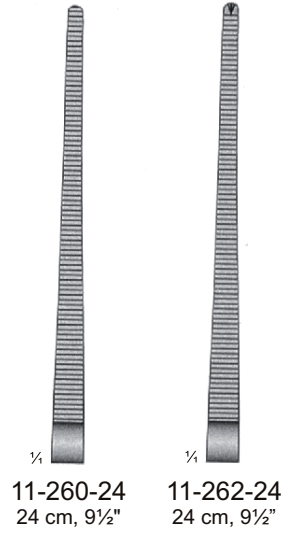
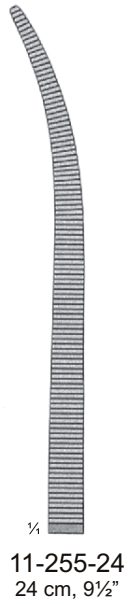
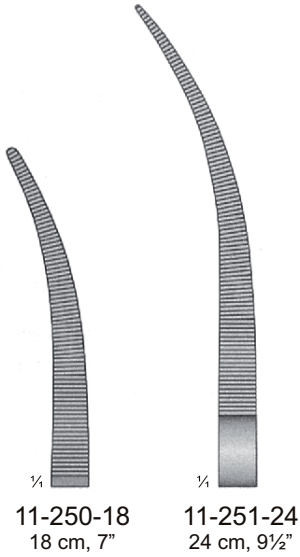
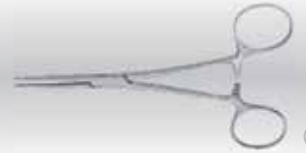

1x2 Teeth
 1x2 Zähne
 1x2 Dientes
 1x2 Dents
 1x2 Denti

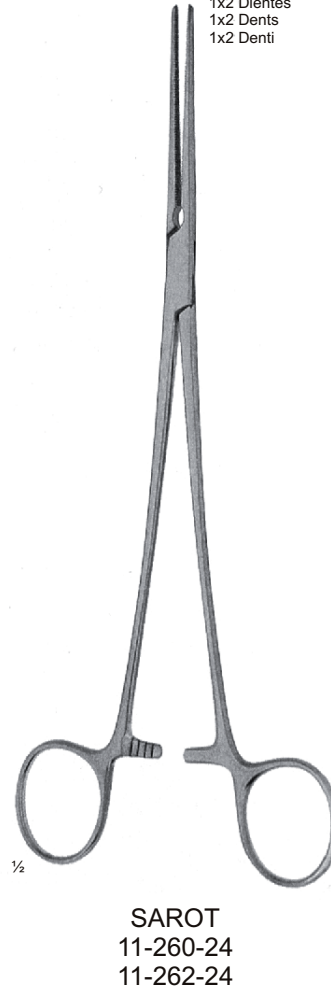

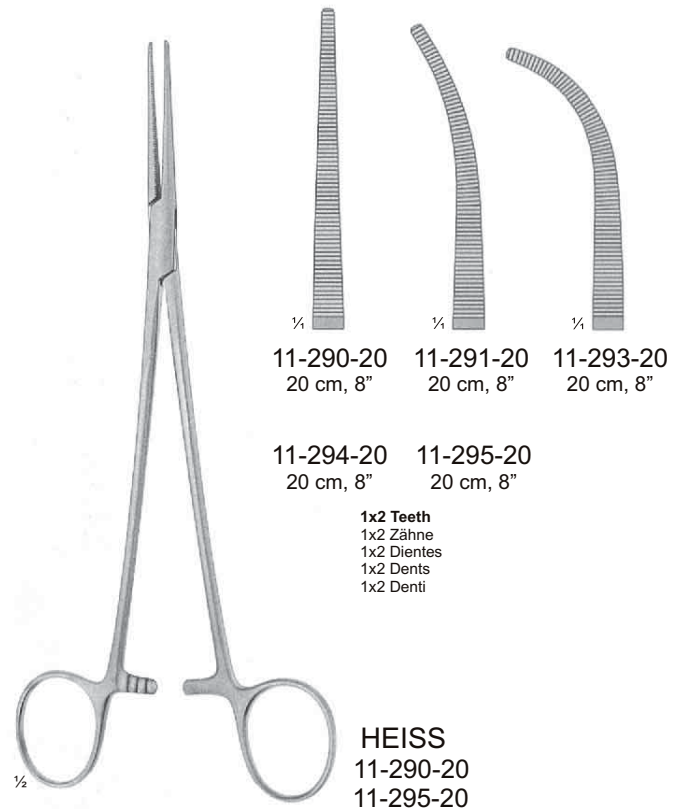
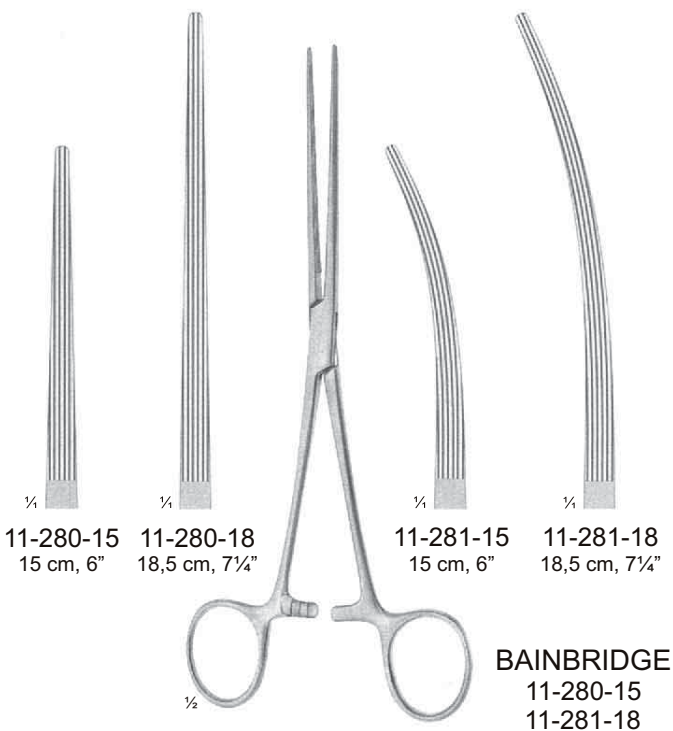
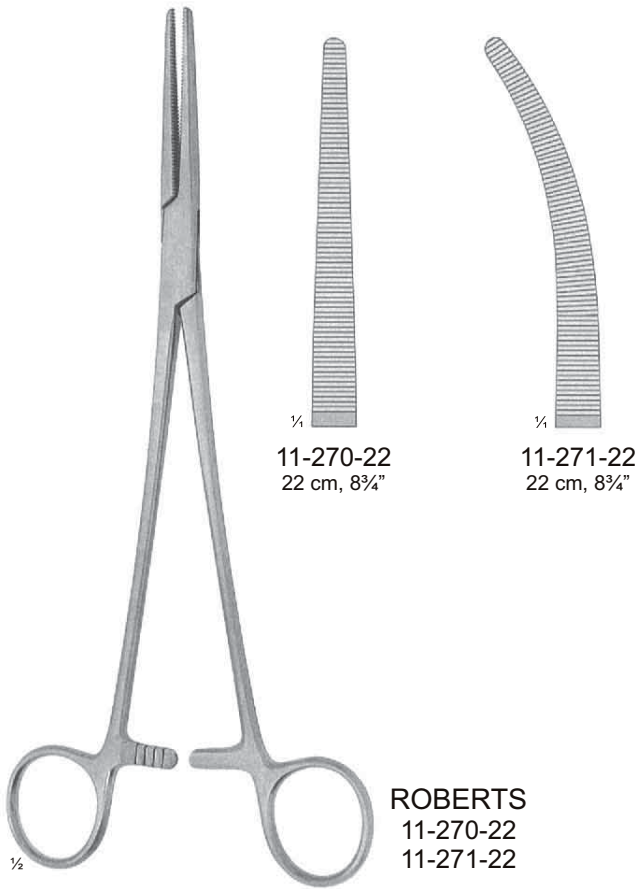
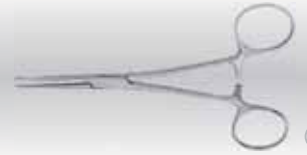

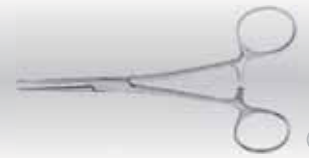

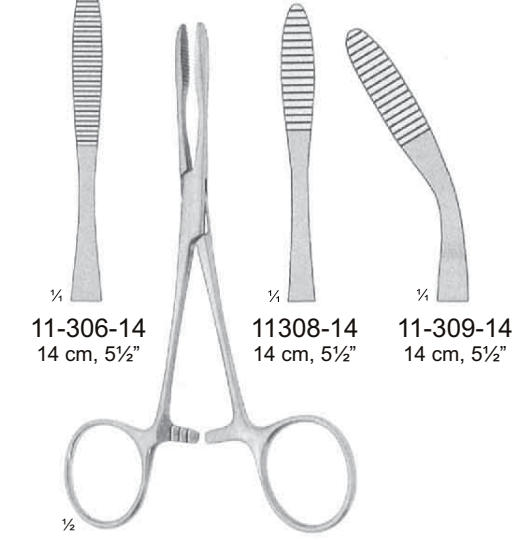

$\frac{1}{4}$ 11-300-12 12,5 cm, 5"
 $\frac{1}{4}$ 11-300-16 16,5 cm, 6½"
 $\frac{1}{4}$ 11-300-18 18,5 cm, 7¼"

$\frac{1}{2}$
PEAN
 11-300-12
 11-300-18

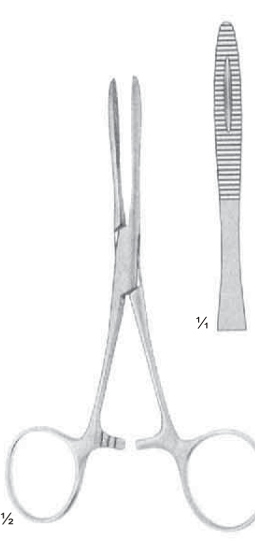

$\frac{1}{4}$ 11-306-14 14 cm, 5½"
 $\frac{1}{4}$ 11308-14 14 cm, 5½"
 $\frac{1}{4}$ 11-309-14 14 cm, 5½"

$\frac{1}{2}$
PEAN
 11-306-14
 11-309-14



$\frac{1}{4}$

$\frac{1}{2}$
KROENLEIN
 11-316-13
 13 cm, 5"

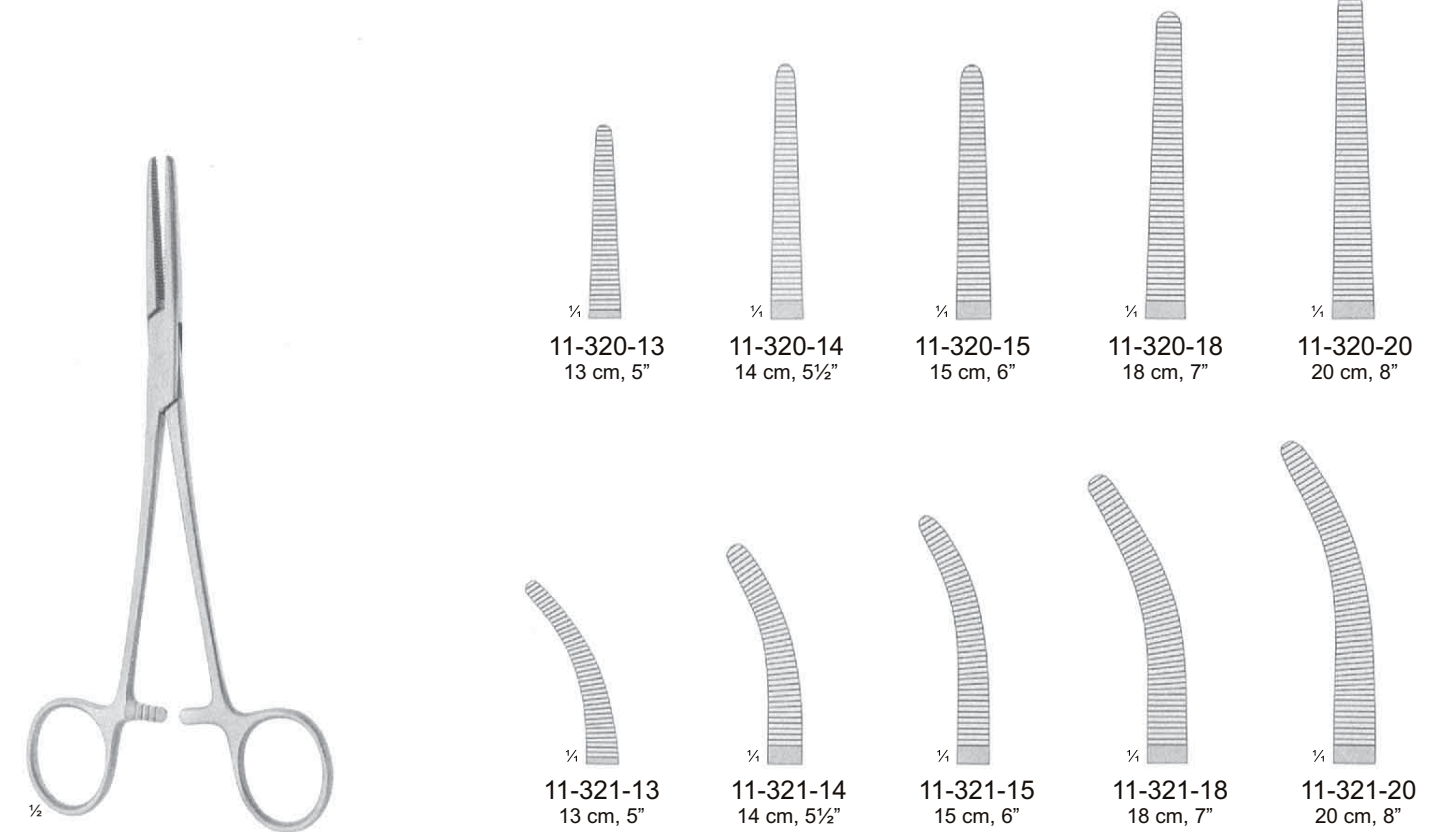

$\frac{1}{4}$ 11-320-13 13 cm, 5"
 $\frac{1}{4}$ 11-320-14 14 cm, 5½"
 $\frac{1}{4}$ 11-320-15 15 cm, 6"
 $\frac{1}{4}$ 11-320-18 18 cm, 7"
 $\frac{1}{4}$ 11-320-20 20 cm, 8"

$\frac{1}{4}$ 11-321-13 13 cm, 5"
 $\frac{1}{4}$ 11-321-14 14 cm, 5½"
 $\frac{1}{4}$ 11-321-15 15 cm, 6"
 $\frac{1}{4}$ 11-321-18 18 cm, 7"
 $\frac{1}{4}$ 11-321-20 20 cm, 8"

$\frac{1}{2}$
SPENCER-WELLS
 11-320-13
 11-321-20



Haemostatic Forceps
 Arterienklemmen
 Pinzas hemostáticas
 Pincas hémostatiques
 Pinze emostatiche

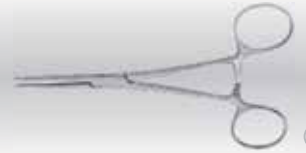

011

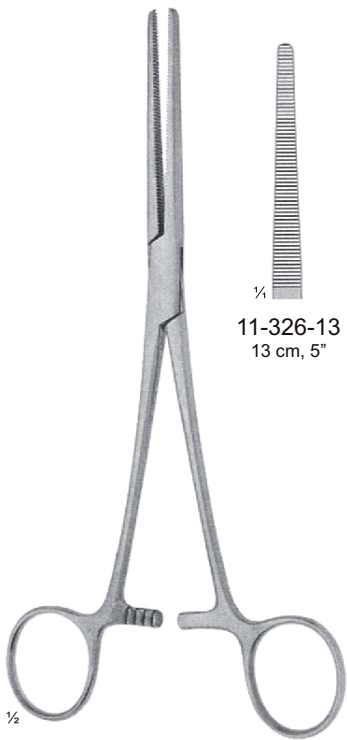

1/2

PEAN-ROCHESTER
 11-326-13
 11-327-30

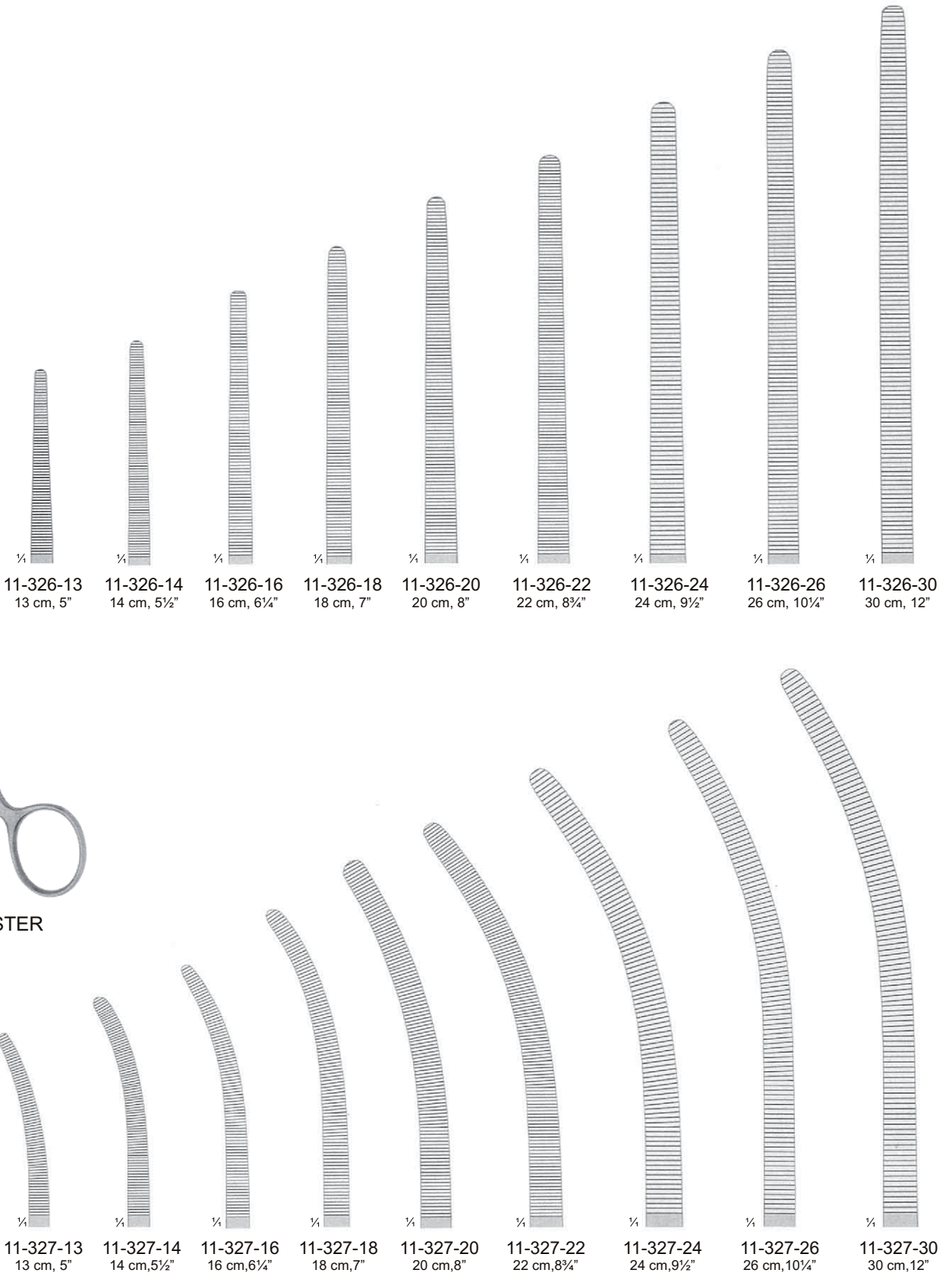

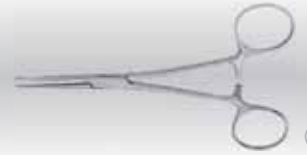

¼

11-330-13
13 cm, 5"

¼

11-330-14
14 cm, 5½"

¼

11-330-16
16 cm, 6¼"

½

PEAN
 11-330-13
 11-331-16

¼

11-331-13
13 cm, 5"

¼

11-331-14
14 cm, 5½"

¼

11-331-16
16 cm, 6¼"

Delicate patterns
 Feine modeile
 Modelos finos
 Modèles fins
 Modelli delicati

¼

11-332-14
14 cm, 5½"

¼

11-332-16
16,5 cm, 6½"

¼

11-332-18
18,5 cm, 7¼"

½

PEAN-DE BAKEY
 11-332-14
 11-333-18

¼

11-333-14
14 cm, 5½"

¼

11-333-16
16,5 cm, 6½"

¼

11-333-18
18,5 cm, 7¼"

ATRAUMA



Haemostatic Forceps
 Arterienklemmen
 Pinzas hemostáticas
 Pincés hémostatiques
 Pinze emostatiche



011

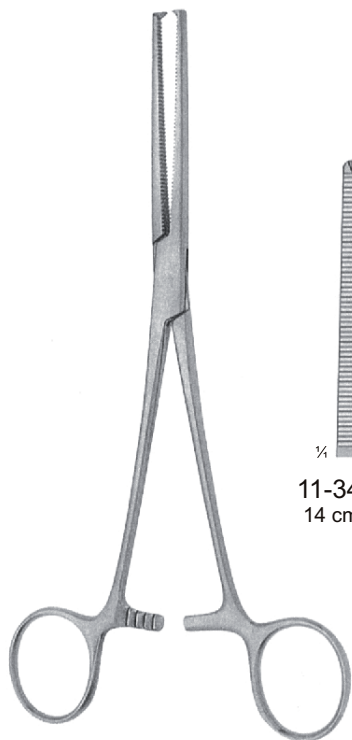

KOCHER-OCHSNER
 11-340-14
 11-341-30

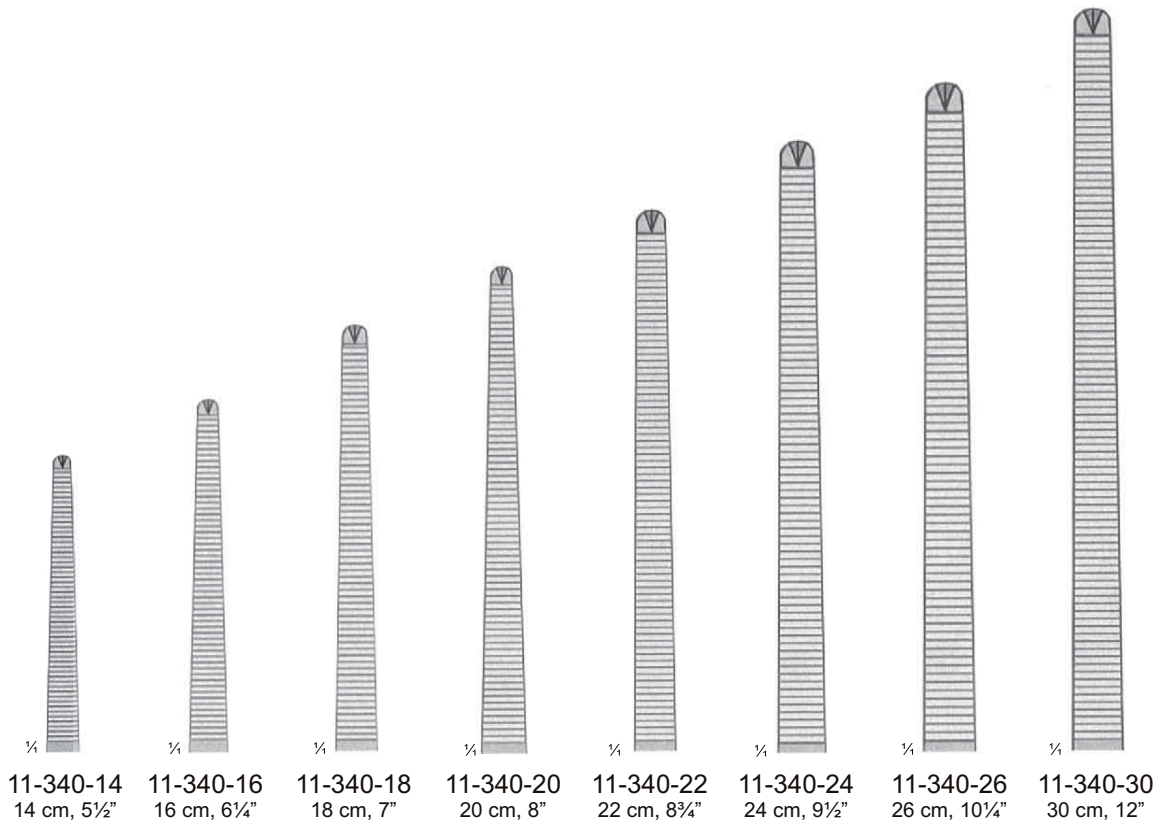

1x2 Teeth
 1x2 Zähne
 1x2 Dientes
 1x2 Dents
 1x2 Denti

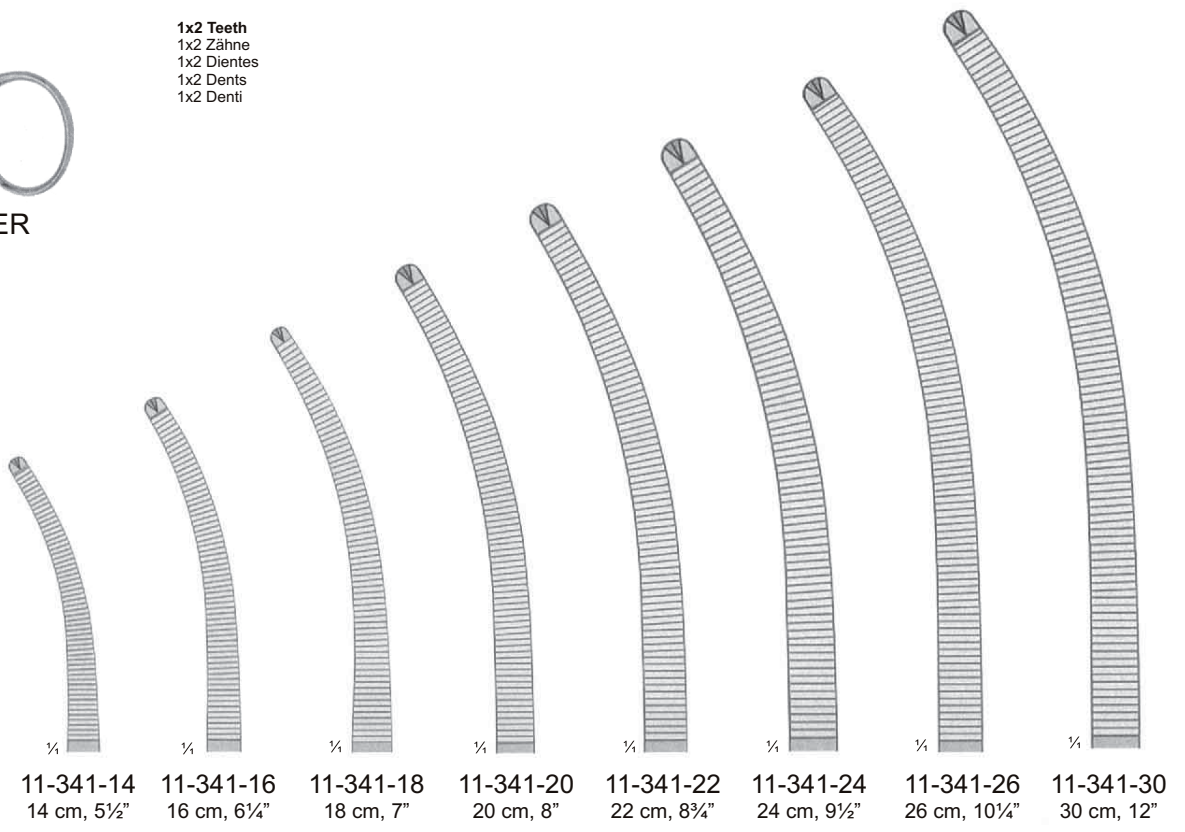

1x2 Teeth
 1x2 Zähne
 1x2 Dientes
 1x2 Dents
 1x2 Denti

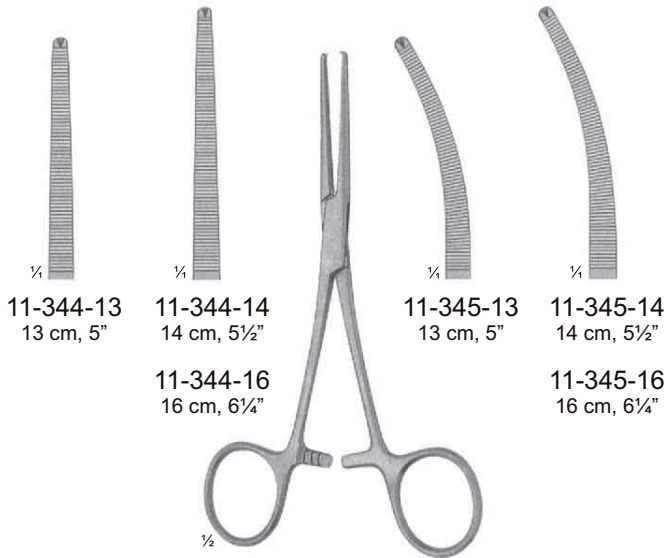
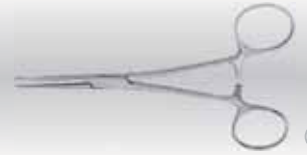

11-344-13
13 cm, 5"

11-344-14
14 cm, 5½"

11-345-13
13 cm, 5"

11-345-14
14 cm, 5½"

11-344-16
16 cm, 6¼"

11-345-16
16 cm, 6¼"



1x2 Teeth
1x2 Zähne
1x2 Dientes
1x2 Dents
1x2 Denti

KOCHER
11-344-13
11-345-16

Delicate patterns
Feine modelle
Modelos finos
Modèles fins
Modelli delicati

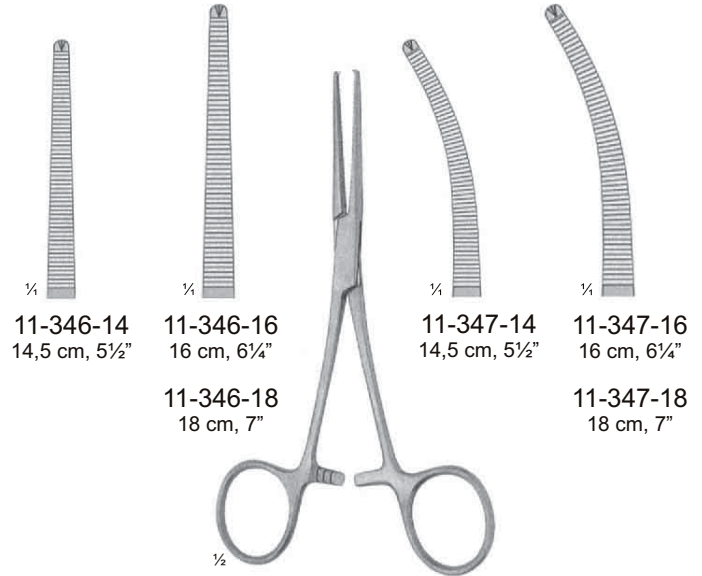

11-346-14
14,5 cm, 5½"

11-346-16
16 cm, 6¼"

11-347-14
14,5 cm, 5½"

11-347-16
16 cm, 6¼"

11-346-18
18 cm, 7"

11-347-18
18 cm, 7"



1x2 Teeth
1x2 Zähne
1x2 Dientes
1x2 Dents
1x2 Denti

KOCHER-NIPPON
11-346-14
11-347-18

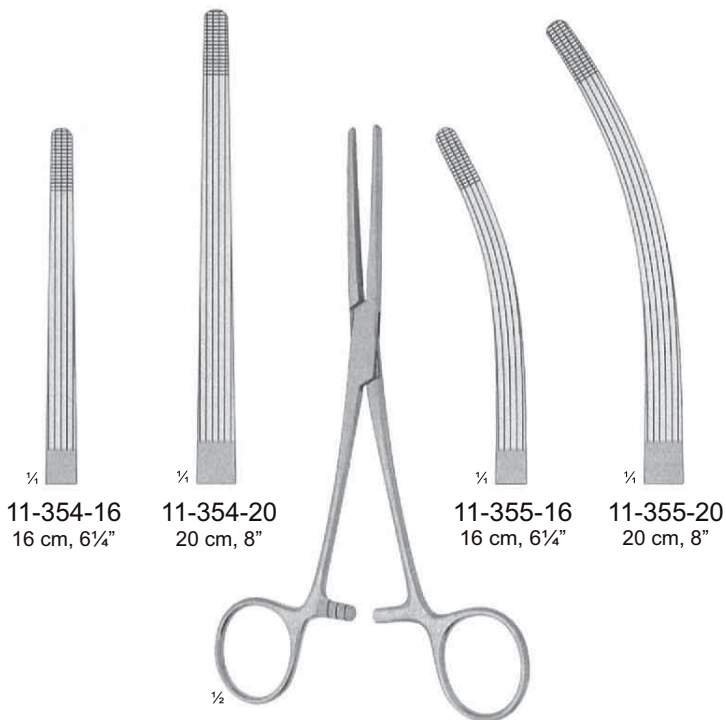

11-354-16
16 cm, 6¼"

11-354-20
20 cm, 8"

11-355-16
16 cm, 6¼"

11-355-20
20 cm, 8"



ROCHSTER-CARMALT
11-354-16
11-355-20

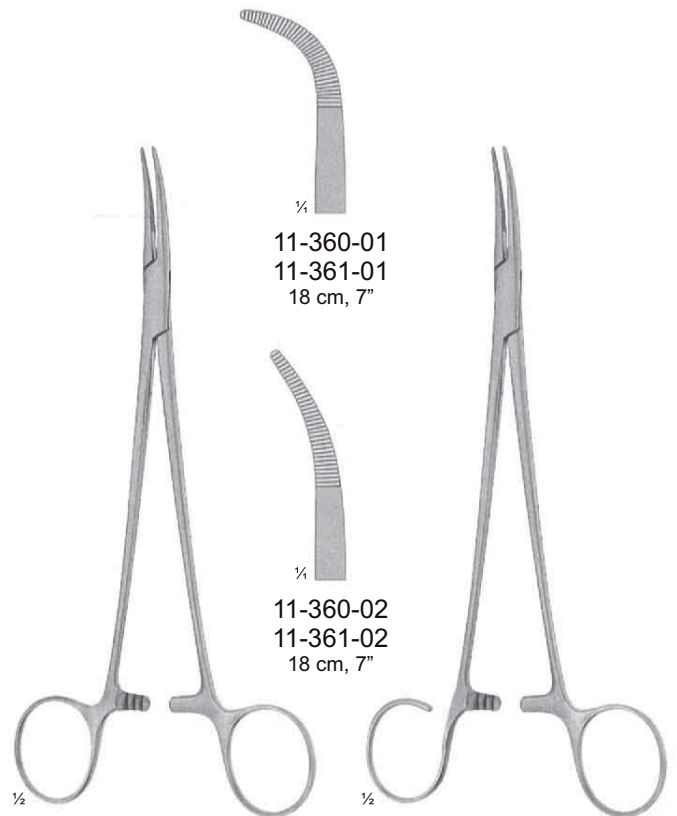

11-360-01
11-361-01
18 cm, 7"

11-360-02
11-361-02
18 cm, 7"



SCHNIDT
11-360-01
11-360-02

SCHNIDT
11-361-01
11-361-02

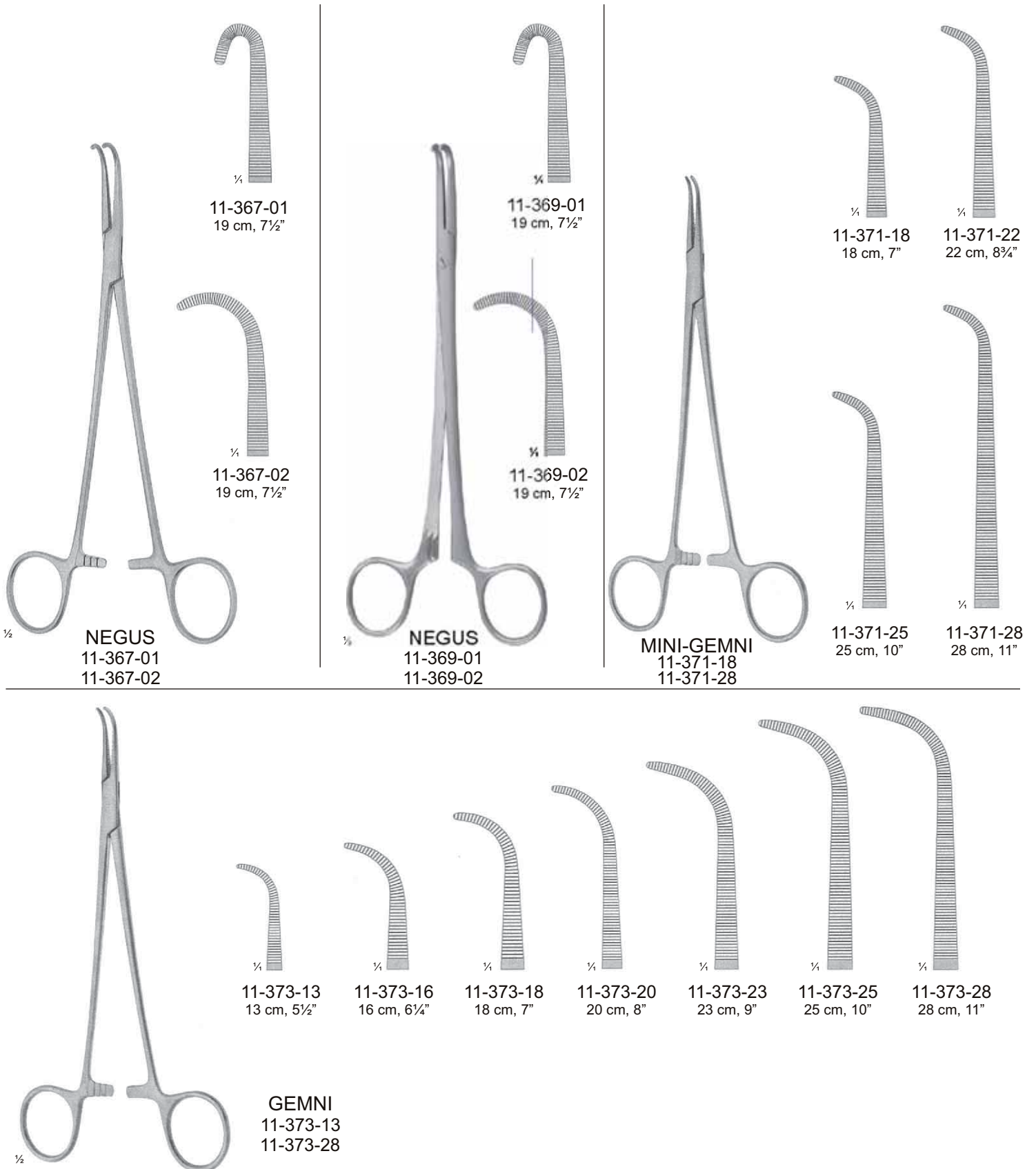
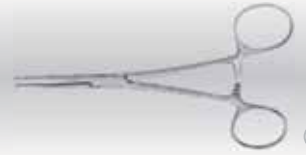

Dissecting and Ligature Forceps

Präparier- und Ligaturklemmen
 Pinzas de disección y ligaduras
 Pincas à disséquer et à ligatures
 Pinze per preparazioni e legature

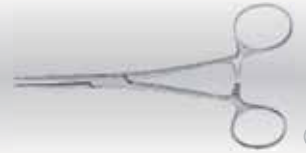

KELLY
 11-381-01
 11-385-03

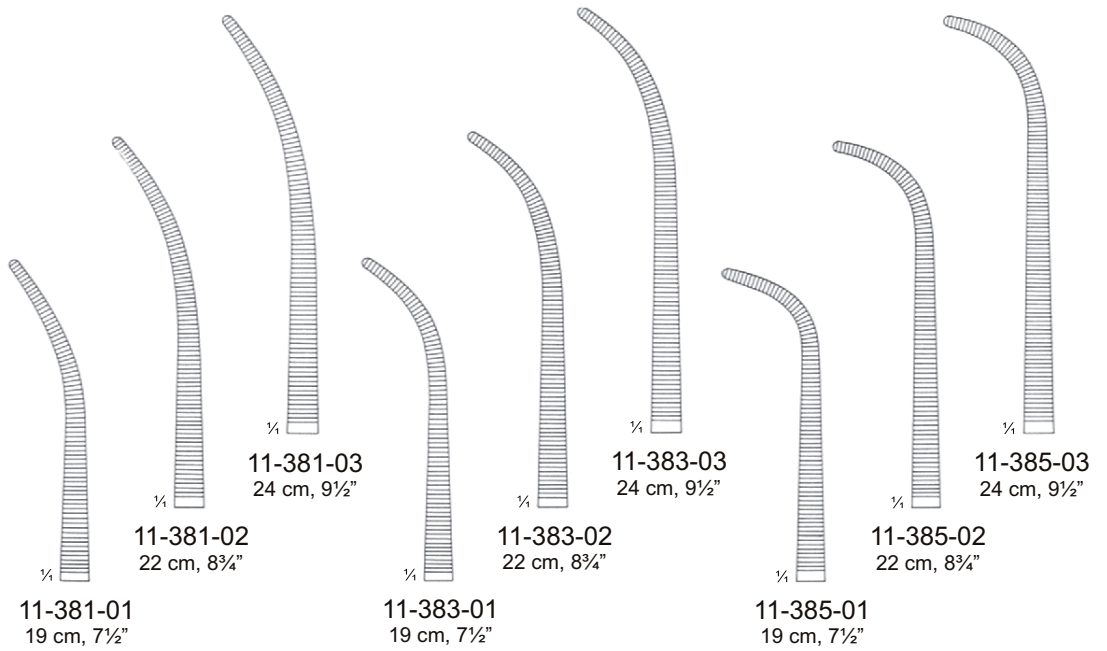

BABY MIXTER
 11-391-14
 11-391-18

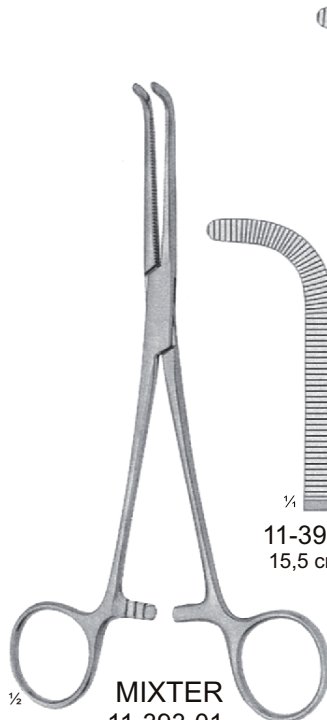
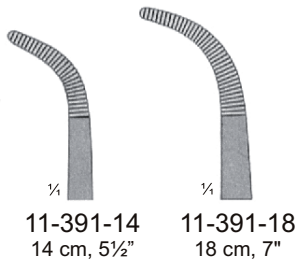

MIXTER
 11-393-01
 11-393-05

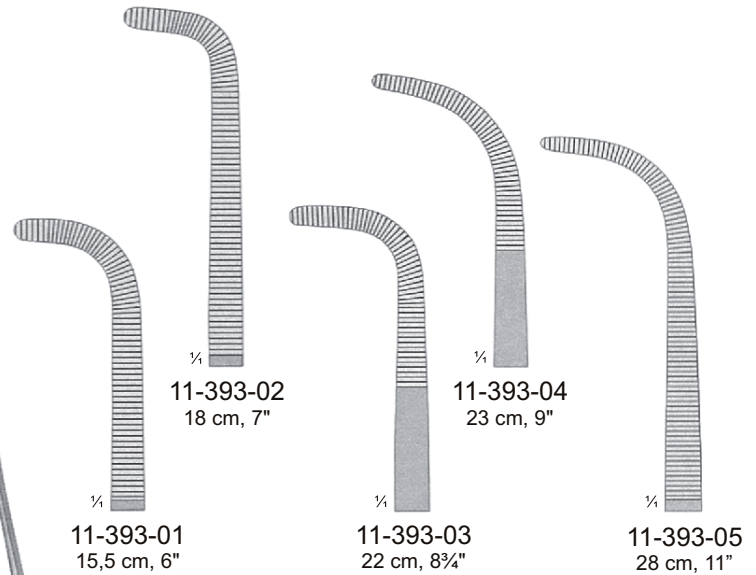

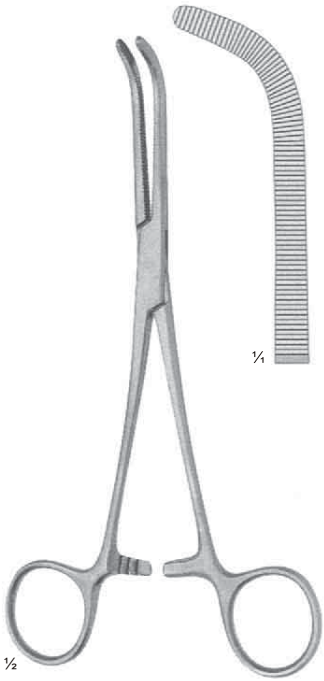
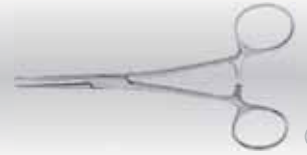

MIXTER-O'SHAUGHNESSY
 11-397-19
 19 cm, 7½"

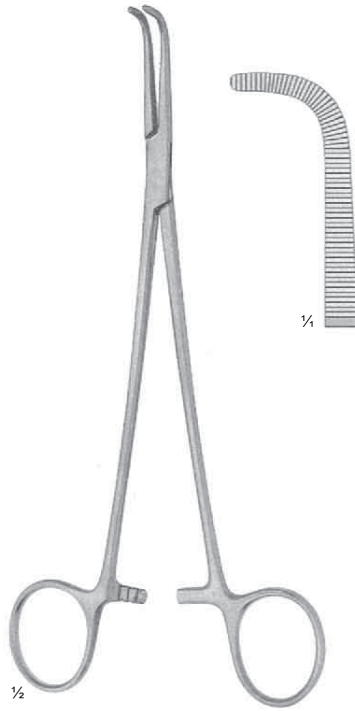

MIXTER-PAUL
 11-399-20
 20 cm, 8"

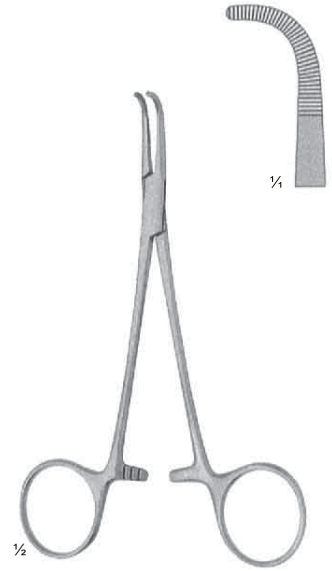

BABY-MEEKER
 11-405-13
 13 cm, 5"

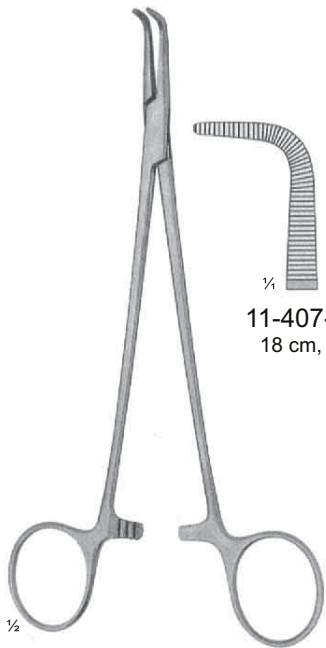

MEEKER
 11-407-18
 11-407-27

11-407-18
 18 cm, 7"

11-407-27
 27,5 cm, 10¾"

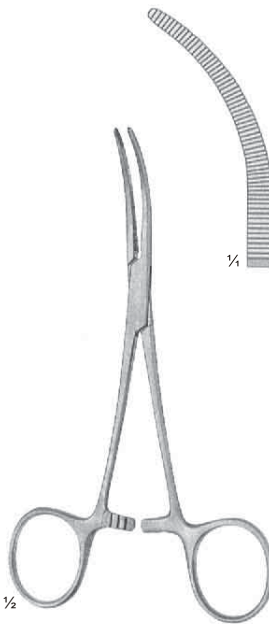

BABY-OVERHOLT
 11-411-13
 13,5 cm, 5¼"

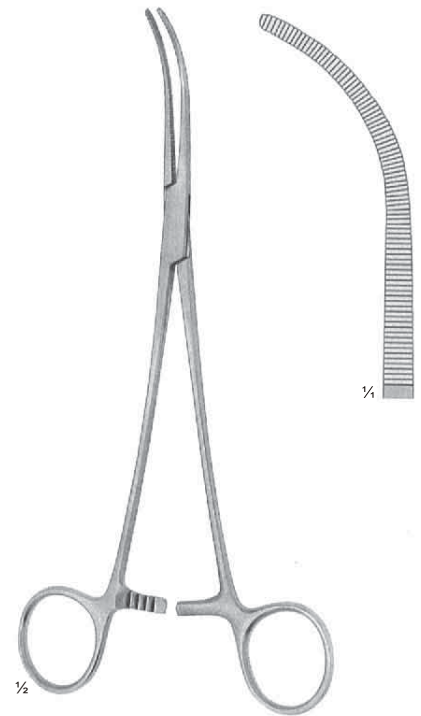

OVERHOLT-MIXTER
 11-413-21
 21 cm, 8¼"

Dissecting and Ligature Forceps

Präparier- und Ligaturklemmen
 Pinzas de disección y ligaduras
 Pincas à disséquer et à ligatures
 Pinze per preparazioni e legature

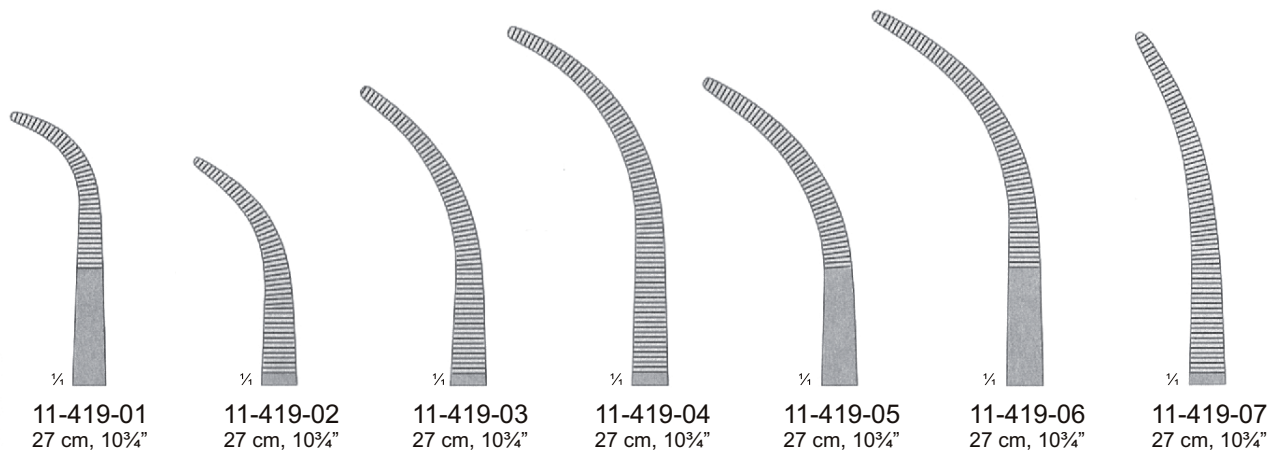
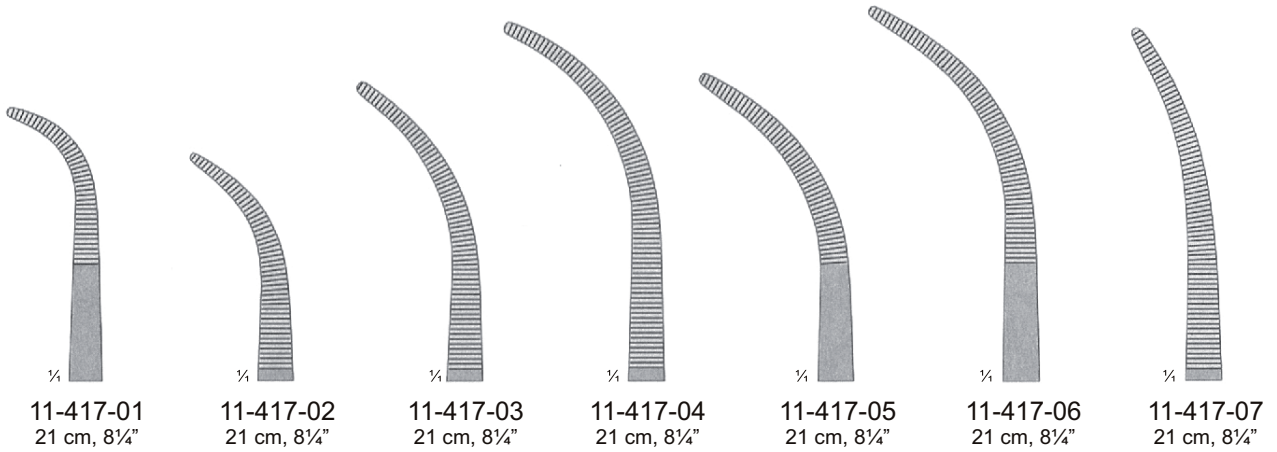
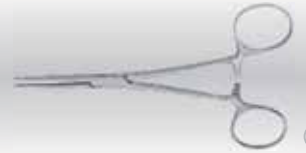

OVERHOLT
 GEISSENDOERFER
 11-417-01
 11-419-07

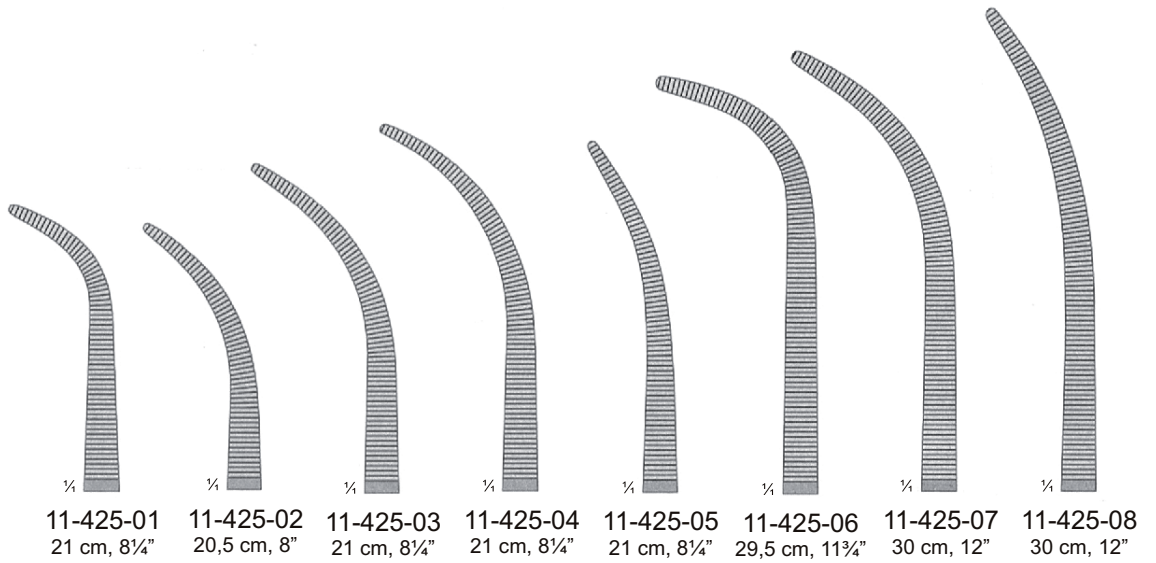
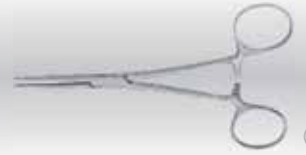

OVERHOLT
 11-425-01
 11-425-08

Delicate patterns
 Feine modelle
 Modelos finos
 Modèles fins
 Modelli delicati

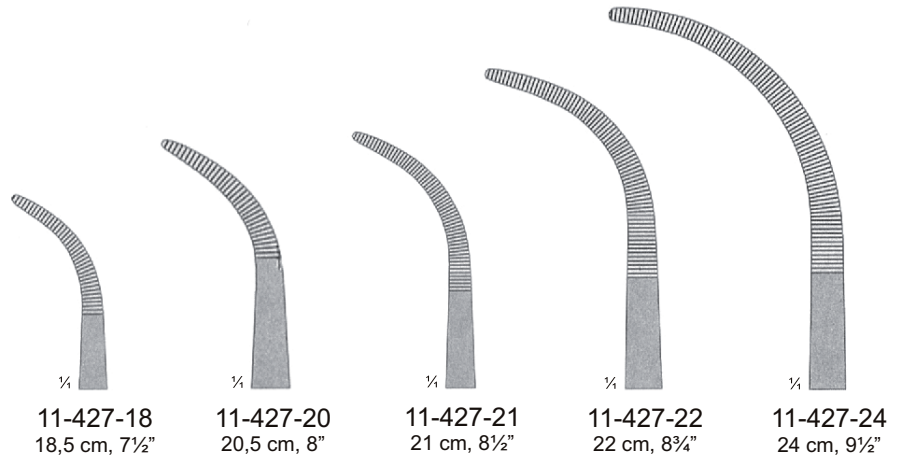

OVERHOLT-MARTIN
 11-427-18
 11-427-24

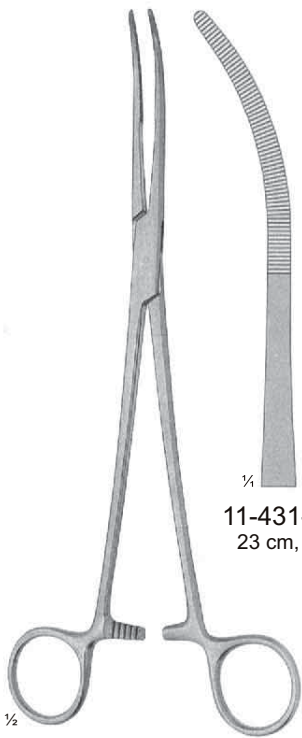
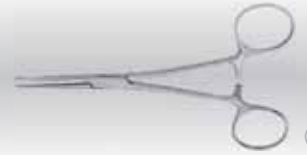

11-431-01
23 cm, 9"

11-431-02
23 cm, 9"

11-431-03
23 cm, 9"

11-431-04
23 cm, 9"

RUMEL
11-431-01
11-431-04

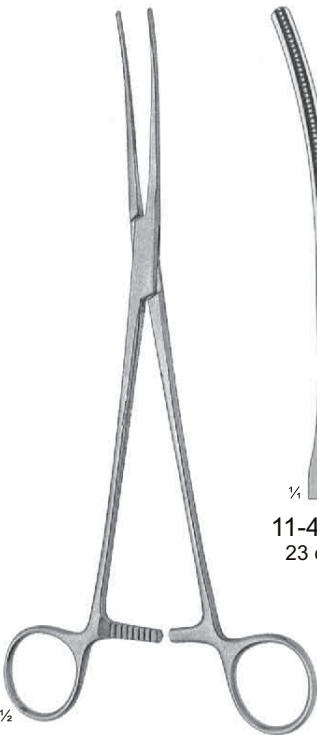

11-433-01
23 cm, 9"

11-433-02
23 cm, 9"

11-433-03
23 cm, 9"

11-433-04
23 cm, 9"

**RUMEL
DE BAKEY**
11-433-01
11-433-04

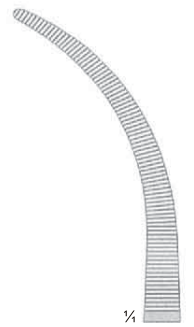

11-437-01
29,5 cm, 11½"



11-437-02
29,5 cm, 11½"

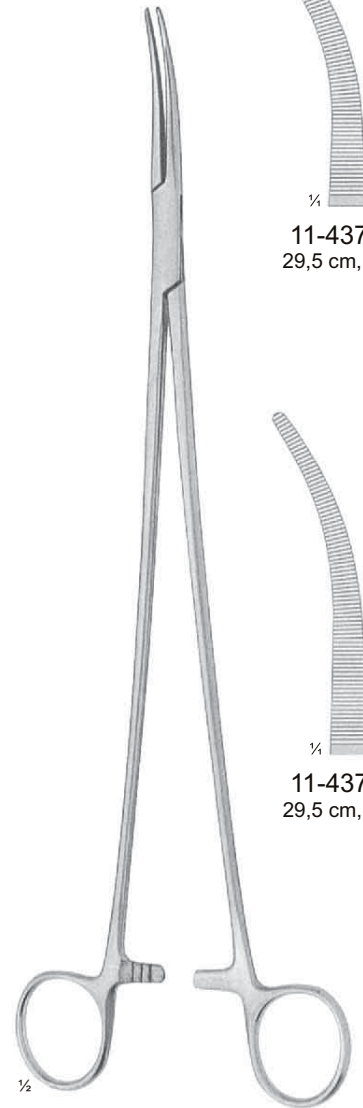

ZENKER
11-437-01
11-437-02

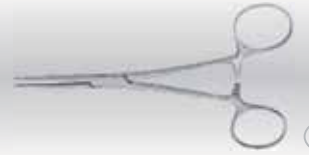

¼



¼



¼

11-447-22
22 cm, 8¾"



¼

11-447-25
25 cm, 10"

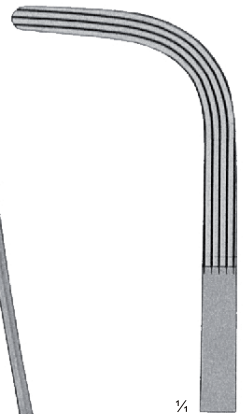

¼

11-447-28
28 cm, 11"



½

BRIDGE
11-441-27
27,5 cm, 10¾"



½

MEEKER
11-445-27
27,5 cm, 10¾"



½

MIXTER
11-447-22
11-447-28

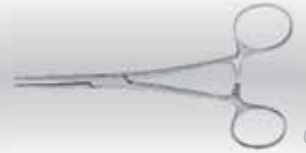

¼



½

LAWRENCE
 11-451-27
 27,5 cm, 10¾"



½

LAHEY
 11-455-19
 11-455-23



¼

11-455-19
 19 cm, 7½"

¼

11-455-23
 23 cm, 9"



½

LAHEY-SWEET
 11-459-20
 20 cm, 8"

¼

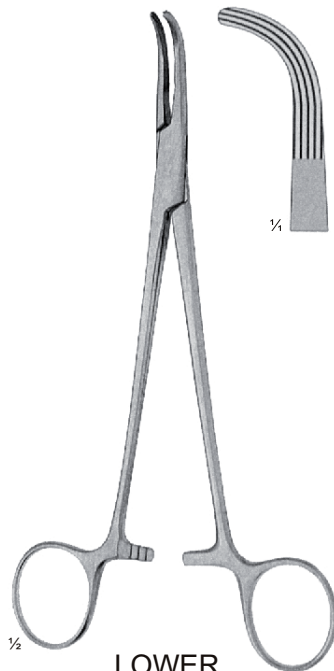

½

LOWER
 11-463-18
 18 cm, 7"



¼

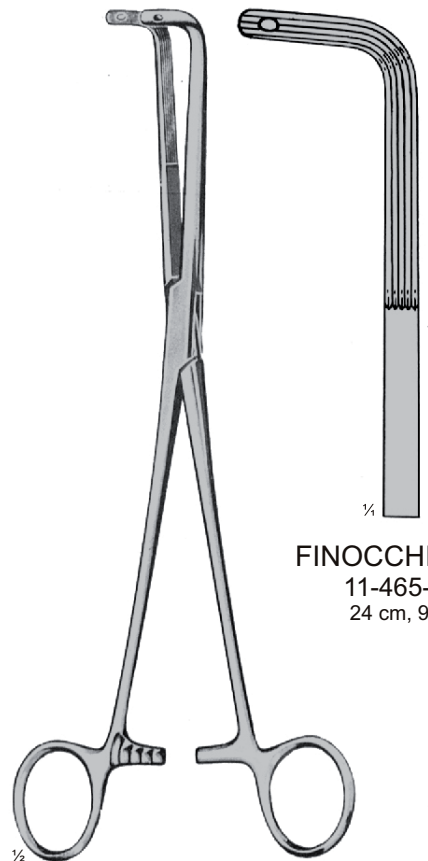

½

FINOCCHIETTO
 11-465-24
 24 cm, 9½"

¼

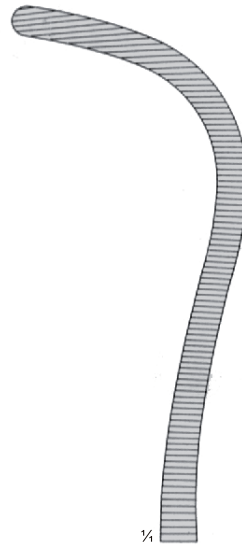
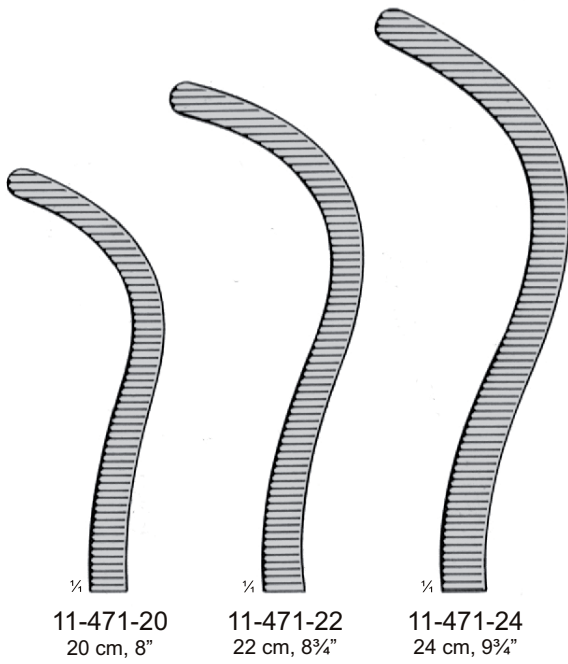
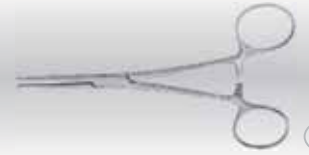

GUYON
 11-471-20
 11-471-24



GUYON
 11-475-23
 23 cm, 9"



GUYON
 11-479-23
 11-479-24



Peritoneum Forceps

Peritoneumklemmen
Pinzas-clamps para peritoneo
Pincas-clamps pour le péritoine
Pinze per peritoneo

Hysterectomy forceps

Hysterektomieklappen
Pinzas-clamps para histerectomia
Pincas à hystérectomie
Pinze per isterectomia

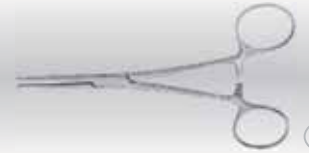

011

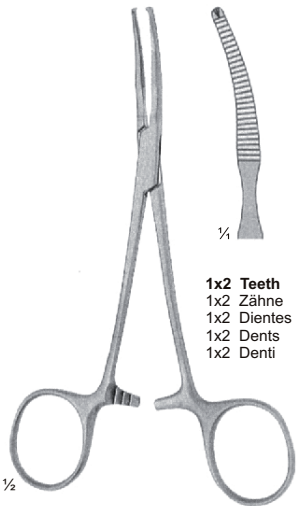

1x2 Teeth
1x2 Zähne
1x2 Dientes
1x2 Dents
1x2 Denti

BABY-MIKULICZ
11-481-14
14 cm, 5½"

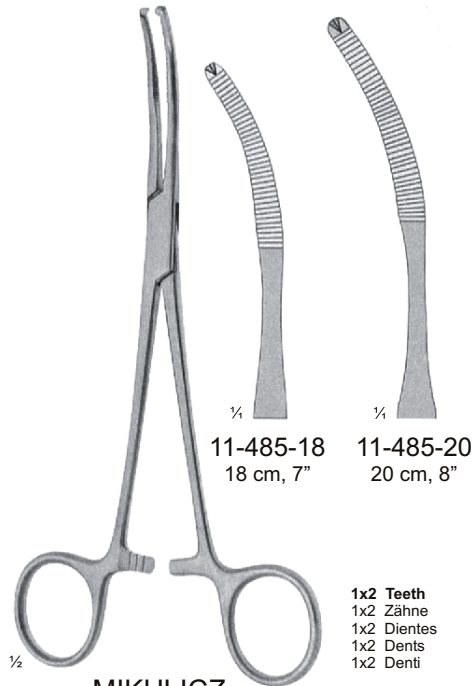

11-485-18
18 cm, 7"
11-485-20
20 cm, 8"

1x2 Teeth
1x2 Zähne
1x2 Dientes
1x2 Dents
1x2 Denti

MIKULICZ
11-485-18
11-485-20

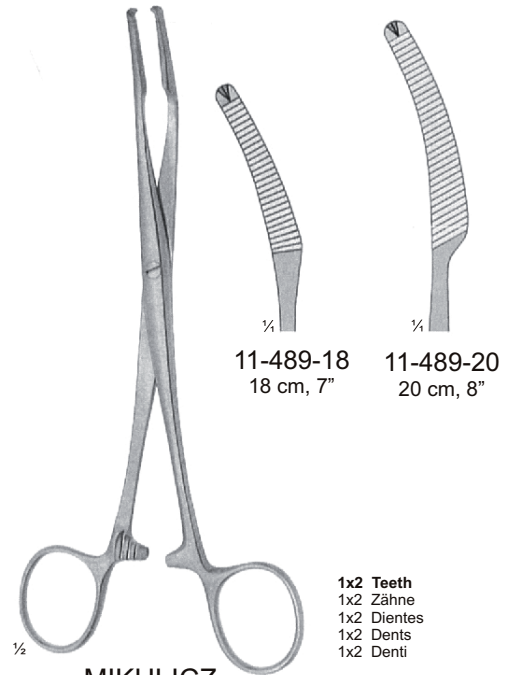

11-489-18
18 cm, 7"
11-489-20
20 cm, 8"

1x2 Teeth
1x2 Zähne
1x2 Dientes
1x2 Dents
1x2 Denti

MIKULICZ
11-489-18
11-489-20

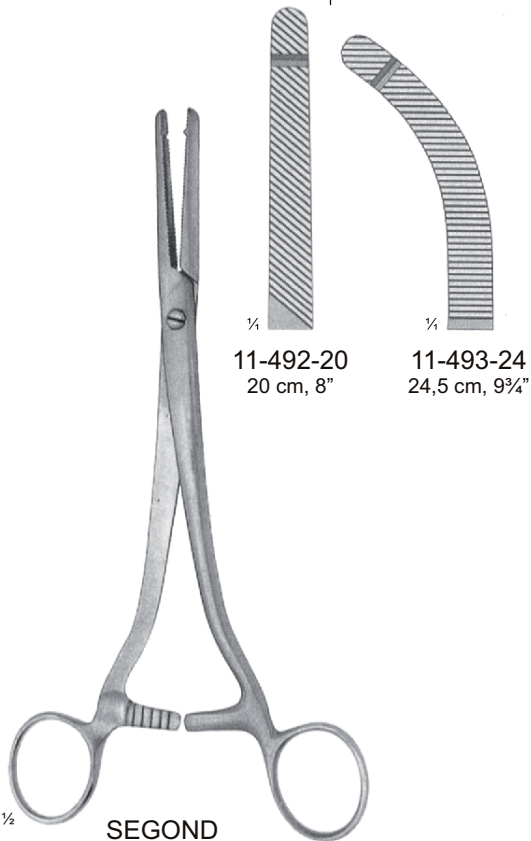

11-492-20
20 cm, 8"

11-493-24
24,5 cm, 9¾"

SEGOND
11-492-20
11-493-24

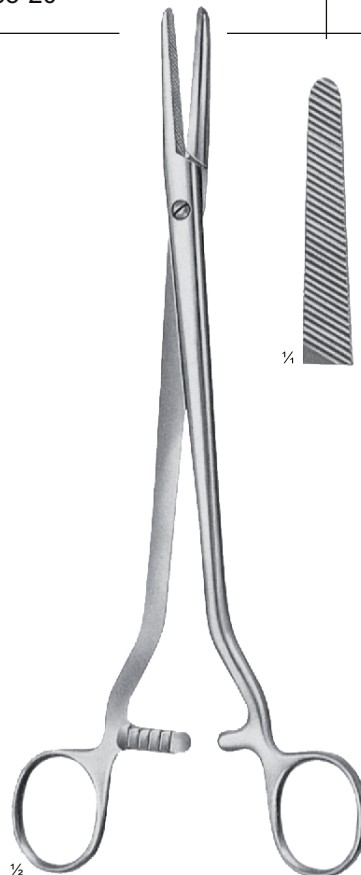

SEGOND-LANDAU
11-496-24
24 cm, 9½"

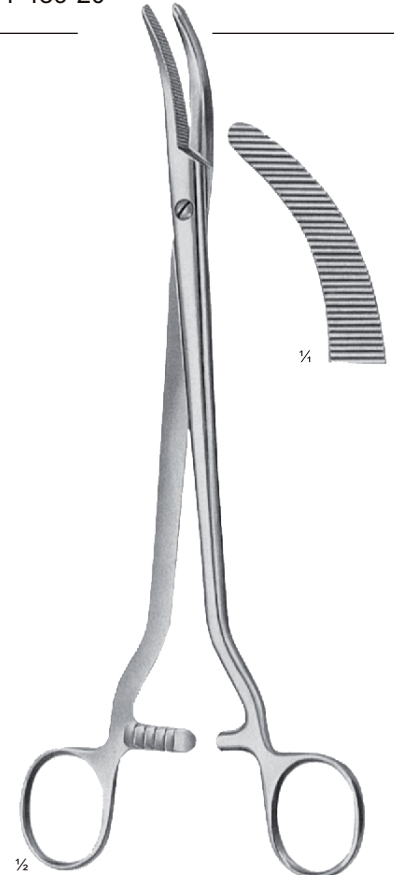

SEGOND-LANDAU
11-497-24
24 cm, 9½"



Peritoneum Forceps

Peritoneumklemmen
Pinzas-clamps para peritoneo
Pincas-clamps pour le péritoine
Pinze per peritoneo

Hysterectomy Forceps

Hysterektomieklemmen
Pinzas-clamps para histerectomía
Pincas à hystérectomie
Pinze per istercetomia



011

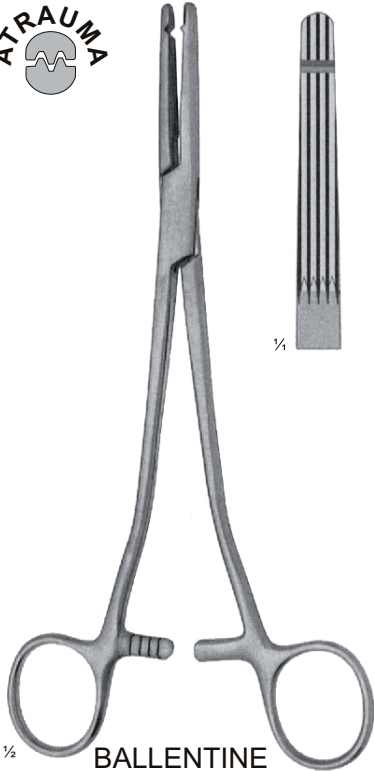

¼

½ **BALLENTINE**
11-500-21
21,5 cm, 8½"

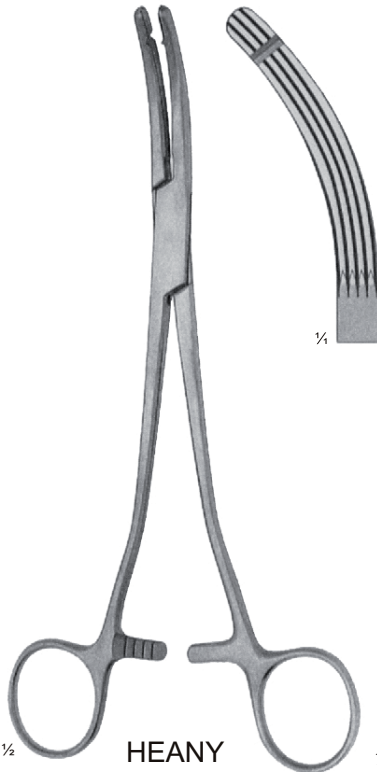

¼

½ **HEANY**
11-501-21
21,5 cm, 8½"

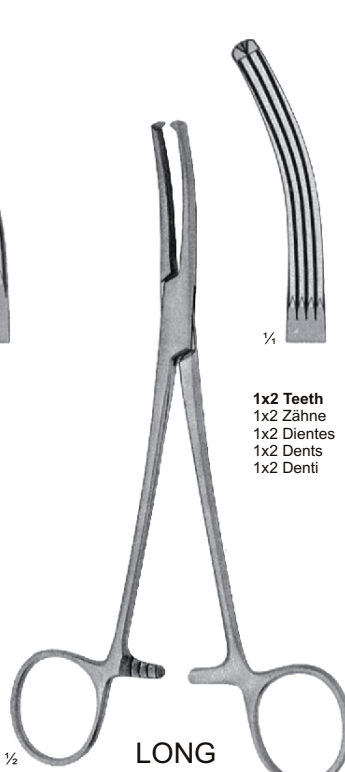

¼

½ **LONG**
11-507-19
19 cm, 7½"

1x2 Teeth
1x2 Zähne
1x2 Dientes
1x2 Dents
1x2 Dentì



11-520-24
24 cm, 9½"



11-521-24
24 cm, 9½"



¼
11-515-01
20 cm, 8"

¼
11-515-02
20 cm, 8"

½ **FAURE**
11-515-01
11-515-02

1x2 Teeth
1x2 Zähne
1x2 Dientes
1x2 Dents
1x2 Dentì



¼
11-519-01
21,5 cm, 8½"

¼
11-519-02
21,5 cm, 8½"

½ **PHANEUF**
11-519-01
11-519-02

1x2 Teeth
1x2 Zähne
1x2 Dientes
1x2 Dents
1x2 Dentì



1x2 Teeth
1x2 Zähne
1x2 Dientes
1x2 Dents
1x2 Dentì

½ **HOLZBACH**
11-520-24
11-521-24

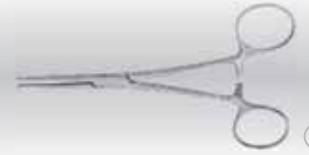

11-529-19
19,5 cm, 7¾"



11-529-21
21 cm, 8¼"



11-529-23
23 cm, 9"

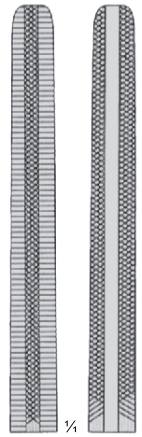

11-532-20
20 cm 8"



11-531-19
19,5 cm, 7¾"



11-531-21
21 cm, 8¼"



11-531-23
23 cm, 9"

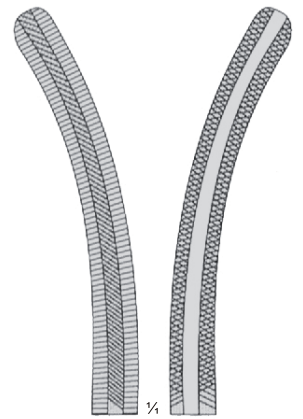

11-533-20
20 cm 8"



HEANEY
11-529-19
11-531-23



FERGUSON
11-532-20
11-533-20



Hysterectomy Forceps with non-traumatic serration
 Hysterektomieklemmen Mit atraumatischer Riefung
 Pinzas-clamps para histerectomía Con bocas atraumáticas
 Pincès à hystérectomie Avec mors atrauma
 Pinze per istercetomia Con morsi atraumatici

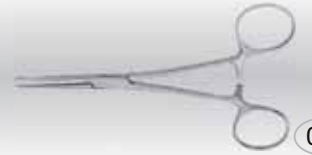

011



$\frac{1}{4}$
 11-540-01
 24,5 cm, 9 $\frac{3}{4}$ "

$\frac{1}{4}$
 11-540-02
 24,5 cm, 9 $\frac{3}{4}$ "

$\frac{1}{4}$
 11-540-03
 24 cm, 9 $\frac{1}{2}$ "

$\frac{1}{4}$
 11-540-04
 23,5 cm, 9 $\frac{1}{4}$ "

$\frac{1}{4}$
 11-540-05
 22,5 cm, 9"



Parametrium forceps
 Parametriumklemmen
 Pinzas-clamps parametrium
 Pincès-clamps pour ligaments larges
 Pinze-clamps per parametrio

**WERTHEIM
 DE BAKEY**
 11-540-01
 11-540-05



$\frac{1}{4}$
 11-541-01
 22,5 cm, 8 $\frac{3}{4}$ "

$\frac{1}{4}$
 11-541-02
 22,5 cm, 8 $\frac{3}{4}$ "

$\frac{1}{4}$
 11-541-03
 21,5 cm, 8 $\frac{1}{2}$ "

$\frac{1}{4}$
 11-541-04
 21 cm, 8"

$\frac{1}{4}$
 11-541-05
 20 cm, 8"



**HEANEY
 DE BAKEY**
 11-541-01
 11-541-05

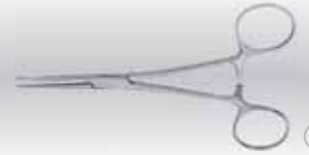

HERRICK
 11-545-23
 23 cm, 9"

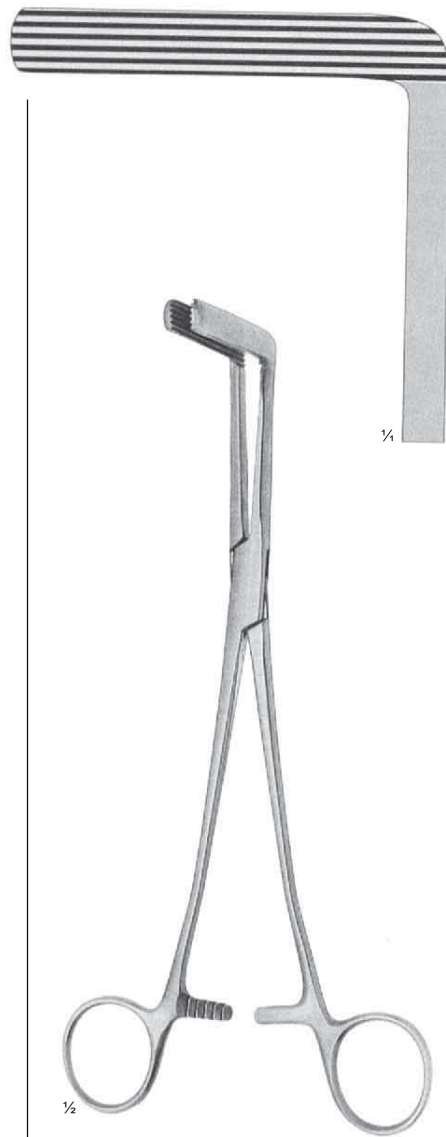

WERTHEIM-CULLEN
 11-549-21
 21,5 cm, 8½"

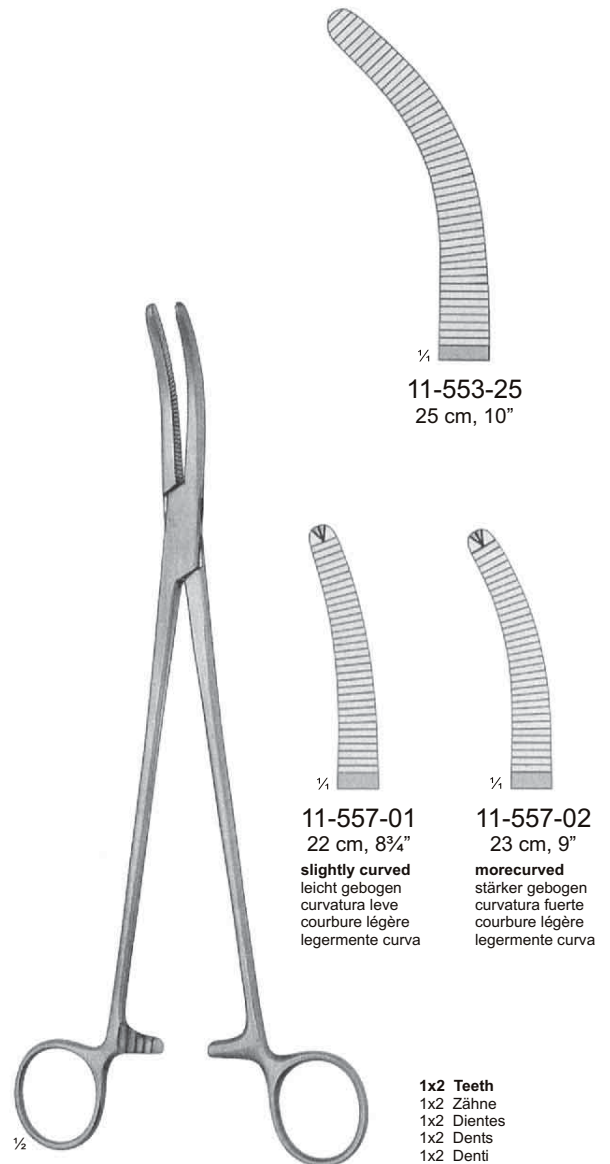

WERTHEIM
 11-553-25

WERTHEIM
 11-557-01
 11-557-02

11-557-01
 22 cm, 8¾"
slightly curved
 leicht gebogen
 curvatura leve
 courbure légère
 legermente curva

11-557-02
 23 cm, 9"
morecurved
 stärker gebogen
 curvatura fuerte
 courbure légère
 legermente curva