

EDAN Agile PLM Electronic Signature Information

--Signatures related to this document and performed in EDAN Agile PLM.

文件名称 : SD3说明书_英文

文件编号 : 01.54.455714

版本 : 1.9

产品型号 : SD3 LITE;SD3 PLUS;SD3 PRO;SD3

项目编码(Project Code) : 2209A000

签批信息:

作者 : 周睿 (zhourui) 2019-01-17 10:00:18

审核人 : 刘小倩 (liuxiaoqian) 2019-01-17 13:40:37

审核人 : 余俊煜 (yujunyu) 2019-01-17 10:33:49

批准人 : 吴明花 (wuminghua) 2019-01-18 11:20:19

批准人 : 吴明花 (wuminghua) 2019-01-18 11:20:19

SD3 Series

Ultrasonic Pocket Doppler

User Manual

CE₀₁₂₃



About this Manual

P/N: 01.54.455714

Version 1.9

MPN: 01.54.455714019

Release Date: Jan. 2019

© Copyright EDAN INSTRUMENTS, INC. 2013-2019. All rights reserved.

Statement

This manual will help you understand the operation and maintenance of the product better. It is reminded that the product shall be used strictly complying with this manual. User's operation failing to comply with this manual may result in malfunction or accident for which Edan Instruments, Inc. (hereinafter called EDAN) cannot be held liable.

EDAN owns the copyrights of this manual. Without prior written consent of EDAN, any materials contained in this manual shall not be photocopied, reproduced or translated into other languages.

Materials protected by the copyright law, including but not limited to confidential information such as technical information and patent information are contained in this manual, the user shall not disclose such information to any irrelevant third party.

The user shall understand that nothing in this manual grants him, expressly or implicitly, any right or license to use any of the intellectual properties of EDAN.

EDAN holds the rights to modify, update, and ultimately explain this manual.

Responsibility of the Manufacturer

EDAN only considers itself responsible for any effect on safety, reliability and performance of the equipment if:

Assembly operations, extensions, re-adjustments, modifications or repairs are carried out by persons authorized by EDAN, and

The electrical installation of the relevant room complies with national standards, and

The instrument is used in accordance with the instructions for use.

Product Information

Product Name: Ultrasonic Pocket Doppler

Model: SD3 LITE, SD3, SD3 PLUS, SD3 PRO, SD3 VASCULAR

Terms Used in this Manual

This guide is designed to give key concepts on safety precautions.

WARNING

A **WARNING** label advises against certain actions or situations that could result in personal injury or death.

CAUTION

A **CAUTION** label advises against actions or situations that could damage equipment, produce inaccurate data, or invalidate a procedure.

NOTE

A **NOTE** provides useful information regarding a function or a procedure.

Table of Contents

Chapter 1 Safety Guide.....	1
1.1 Intended Use/Indications for Use	1
1.2 Safety Precautions	1
1.3 Symbols	6
Chapter 2 Doppler and Accessories.....	8
2.1 Features	8
2.2 Main Unit	9
2.2.1 Appearance.....	9
2.2.2 Display Panel.....	10
2.2.3 Buttons	12
2.2.4 Socket	12
2.2.5 Probe Socket.....	13
2.2.6 Batteries.....	13
2.3 Probes	14
2.3.1 Waterproof Obstetrical Probes	14
2.3.2 Waterproof Vascular Probes	14
Chapter 3 Basic Operation	15
3.1 Opening the Package and Checking.....	15
3.2 Installing/Replacing Battery.....	15
3.3 Probe Operation.....	16
3.4 Switching On.....	17
3.5 Switching Off	17
3.6 Replacing/Charging the Battery	17
3.6.1 Battery Energy Indication	17
3.6.2 Replacing Alkaline Batteries.....	18
3.6.3 Charging the NI-MH Batteries	18
3.6.4 Charging the Doppler (SD3 PLUS, SD3 PRO).....	19
3.6.5 Charging the Charge Stand	19
Chapter 4 Examining	21
4.1 FH Examining	21
4.2 FH Sound Recording and Playing	22
4.3 FH Sound Recording by PC	22
4.3.1 Recording Sounds	22
4.3.2 Playing Sound Files.....	23
4.3.3 Burning CD or Sending in Email	23
4.3.4 Record Troubleshooting	23
4.4 Vascular Examining (Optional)	24
4.5 Completing Examining	26
Chapter 5 Maintenance	27

5.1 Maintenance	27
5.2 Cleaning	27
5.3 Disinfection	27
5.4 Sterilization	28
Chapter 6 Warranty and Service.....	29
6.1 Warranty.....	29
6.2 Contact information.....	29
Appendix 1 Product Specifications	30
Appendix 2 Ordering Information	34
Appendix 3 EMC Information	35
A3.1 Electromagnetic Emissions	35
A3.2 Electromagnetic Immunity	36
A3.3 Electromagnetic Immunity	37
A3.4 Recommended Separation Distances	39
Appendix 4 Ultrasound Intensity and Safety.....	41
A4.1 Ultrasound in Medicine	41
A4.2 Ultrasound Safety and the ALARA Principle	41
A4.3 Explanation of MI/TI.....	41
A4.3.1 MI (Mechanical Index).....	41
A4.3.2 TI (Thermal Index).....	42
A4.3.3 Measurement Uncertainties	42
A4.4 Prudent Use Statement	43
A4.5 References for Acoustic Output and Safety	43
A4.6 Transducer Acoustic Output Parameters List.....	44
A4.7 Track1 Acoustic Output Range Summary.....	49
Appendix 5 Troubleshooting	53
Appendix 6 Overall Sensitivity.....	55

Chapter 1 Safety Guide

CAUTION

Federal (U.S.) Law restricts this device to sale by or on the order of a physician.

NOTE:

This user manual is written to cover the maximum configuration. Therefore, your model may or may not have some of the parameters and functions described, depending on what you have ordered.

1.1 Intended Use/Indications for Use

The SD3 Series Ultrasonic Pocket Dopplers are intended to be used by health care professionals including registered nurses, practical nurses, midwives, ultrasound technicians, and physician assistants, by prescription from licensed physicians in hospitals, clinics and private offices.

The 2 MHz and 3 MHz waterproof probes are indicated for the detection of fetal heart rate from early gestation thru delivery and as a general indication of fetal well being. Specifically, the 3 MHz probe is used for more than 9-week gestation and the 2 MHz is used for 12-week gestation.

The 4 MHz, 5 MHz and/or 8 MHz waterproof vascular probes are indicated for the detection of blood flow in veins and arteries for assisting in the detection of peripheral vascular disease.

1.2 Safety Precautions

Safety of Ultrasound

SD3 was designed with physician and patient safety in mind. In early design phases all potential hazards were eliminated or reduced to As Low As Reasonably Achievable (ALARA) by adhering to good design practices and industry wide safety standards. Ultrasound procedures should be performed with the ALARA principle in mind when delivering ultrasound energy into the body.

The following official statements from the American Institute of Ultrasound Medicine (AIUM) are provided for your general information regarding the safe use of ultrasound.

Clinical Safety (Approved March 1997, October 1982)

Diagnostic ultrasound has been in use since the late 1950s. Given its known benefits and recognized efficacy for medical diagnosis, including use during human pregnancy, the American Institute of Ultrasound in Medicine herein addresses the clinical safety of such use.

There are no confirmed biological effects on patients or instrument operators caused by exposures from present diagnostic ultrasound instruments. Although the possibility exists that such biological effects may be identified in the future, current data indicate that the benefits to

patients of the prudent use of diagnostic ultrasound outweigh the risks, if any that may be present.

Prudent Use (Approved May 1999)

The AIUM advocates the responsible use of diagnostic ultrasound. The AIUM strongly discourages the non-medical use of ultrasound for psychosocial or entertainment purposes. The use of either two-dimensional (2D) or three-dimensional (3D) ultrasound to only view the fetus, obtain a picture of the fetus or determine the fetal gender without a medical indication is inappropriate and contrary to responsible medical practice. Although there are no confirmed biological effects on patients caused by exposures from present diagnostic ultrasound instruments, the possibility exists that such biological effects may be identified in the future. Thus ultrasound should be used in a prudent manner to provide medical benefit to the patient.

Safety in Training and Research (Approved March 1997, March 1983)

Diagnostic ultrasound has been in use since the late 1950s. There are no confirmed adverse biological effects on patients resulting from this usage. Although no hazard has been identified that would preclude the prudent and conservative use of diagnostic ultrasound in education and research, experience from normal diagnostic practice may or may not be relevant to extended exposure times and altered exposure conditions. It is therefore considered appropriate to make the following recommendation:

In those special situations in which examinations are to be carried out for purposes other than direct medical benefit to the individual being examined, the subject should be informed of the anticipated exposure conditions, and of how these compare with conditions for normal diagnostic practice.



This unit is internally powered equipment, and it is an IEC/EN 60601-1 Type B applied part. Type B protection means that the connection between the equipment and personnel complies with permitted leakage currents and dielectric strength of IEC/EN 60601-1.

WARNING and **CAUTION** messages must be observed. To avoid the possibility of injury, observe the following precautions during the operation of the device.

WARNING

- 1 The Doppler is a tool to aid the healthcare professional and should not be used in place of normal fetal monitoring. It is not intended for treatment.
 - 2 Placement of the ultrasound transducer on the abdomen is critical to obtaining the fetal heart beat as opposed to maternal heart beat or other abdominal noise. The user should be trained in proper placement techniques either through acceptable Ob/Gyn training and individual state accreditation, or as being prescribed by such a trained clinician and trained in device placement.
 - 3 This device is not explosion-proof and can not be used in the presence of flammable anaesthetics.
-

WARNING

- 4 Magnetic and electrical fields are capable of interfering with the proper performance of the device. For this reason, make sure that all external devices operated in the vicinity of this device comply with the relevant EMC requirements. X-ray equipment and magnetic resonance imaging (MRI) devices can emit high levels of electromagnetic radiation.
 - 5 This device is MR unsafe. It is not intended for use in an MRI environment.
 - 6 The device is not protected against defibrillation.
 - 7 Do not use the device with HF surgical equipment.
 - 8 Do not touch the signal input/output connector and the patient simultaneously.
 - 9 Only use the probes provided by the manufacturer.
 - 10 We recommend that exposure to ultrasound should be kept as low as reasonably achievable. This is considered to be good practice and should be observed at all time.
 - 11 **SHOCK HAZARD** - Do not attempt to connect or disconnect a power cord with wet hands. Make certain that your hands are clean and dry before touching a power cord.
 - 12 Accessory equipment connected to the analog and digital interfaces must be certified according to the respective IEC/EN standards (e.g. IEC/EN 60950 for data processing equipment and IEC/EN 60601-1 for medical equipment). If in doubt, consult our technical service department or your local distributor.
 - 13 Before using the battery, make sure to read the user manual and safety precautions thoroughly.
 - 14 Do not heat or throw batteries in fire as this may cause explosion.
 - 15 Do not short-circuit the batteries or install the batteries reversely.
 - 16 Do not attempt to charge normal alkaline batteries. They may leak, catch fire or even explode.
 - 17 Do not solder the leading wire and the battery terminal directly.
 - 18 Do not destroy the battery: Do not pierce battery with a sharp object such as a needle; do not hit with a hammer, step on or throw or drop to cause strong shock; do not disassemble or modify the battery.
 - 19 The battery should be charged, used or stored away from the static electricity.
 - 20 Store the batteries in a cool and dry environment.
 - 21 Do not connect the battery cable connector or battery socket with metal objects, which can result in short circuit.
 - 22 If rechargeable batteries are used, charge them fully before initial use by using the method introduced in this manual.
-
-

WARNING

- 23 The rechargeable batteries should be charged by using the dedicated charger supplied by the manufacturer.
 - 24 If the rechargeable batteries are stored alone and not used for a long time, we recommend that the batteries should be charged at least once every 6 months to prevent overdischarge.
 - 25 Replacement of the battery or charging the battery shall be done at least 1.5 meters away from patients.
 - 26 The device shall only be used when the battery cover is closed.
 - 27 If the Doppler is not used for a long time, please remove the battery and store it as required.
 - 28 If the liquid leak from the battery spills onto your skin or clothes, wash well with fresh water immediately.
 - 29 If the liquid leak from the battery gets into eyes, do not rub the eyes. Wash them well with clean water and see a doctor immediately.
 - 30 Keep away from fire immediately when leakage or foul odor is detected.
 - 31 Batteries have life cycles. The alkaline batteries are intended to be used once. If the time that the Doppler using NI-MH battery or lithium battery become much shorter than usual, the battery life is at an end. Replace alkaline or NI-MH batteries with those of identical specifications provided by the manufacturer or purchased locally. Replace lithium batteries with only those provided by the manufacturer.
 - 32 Stop using the battery if abnormal heat, odor, discoloration, deformation or abnormal condition is detected during use, charge, or storage. Please dispose it according to the local regulations.
 - 33 Do not immerse, throw, or wet the battery in water/seawater.
 - 34 Do not connect any equipment or accessories that are not approved by the manufacturer or that are not IEC 60601-1 approved to the device. The operation or use of non-approved equipment or accessories with the device is not tested or supported, and device operation and safety are not guaranteed.
 - 35 Using accessories other than those specified by the manufacturer may result in increased electromagnetic emissions or decreased electromagnetic immunity of the device.
 - 36 The device should not be used adjacent to or stacked with other equipment and that if adjacent or stacked use is necessary, the device should be observed to verify normal operation in the configuration in which it will be used.
 - 37 The medical electrical equipment needs to be installed and put into service according to the EMC Information provided in this user manual.
 - 38 Portable and mobile RF communications equipment can affect medical electrical equipment, refer to section A3.4 Recommended Separation Distances.
 - 39 Do not service or maintain the device or any accessory which is in use with a patient.
-
-

WARNING

- 40 The appliance coupler or mains plug is used as isolation means from supply mains. Position the Doppler in a location where the operator can easily access the disconnection device.
-
-













CAUTION





- 1 Refer servicing to qualified personnel.
- 2 The main unit is designed for continuous operation and is 'ordinary'. Do not immerse it in any liquid (i.e. not drip or splash-proof).
- 3 Keep the device in a clean environment and avoid vibration during storage.
- 4 Do not sterilize the Doppler with autoclave or gas.
- 5 **Electromagnetic Interference** - Ensure that the environment in which the device is operated is not subject to any source of strong electromagnetic emissions, such as radio transmitters, mobile telephones, etc.
- 6 Prior to examination using the Doppler, check for visible damages of the main unit and the probe that may endanger the patient/operator or machine performance. If the damage is found, replace them with good ones at once.
- 7 The following safety checks should be performed once every two years or as specified in the institution's test and inspection protocol by a qualified person who has adequate training, knowledge, and practical experience to perform these tests.
 - ◆ Inspect the equipment for mechanical and functional damage.
 - ◆ Inspect the safety relevant labels for legibility.
 - ◆ Verify that the device functions properly as described in the instructions for use.
 - ◆ Test the pregnant woman's leakage current according to IEC 60601 Limit: d.c 10 μ A, a.c 100 μ A.

The leakage current should never exceed the limit. The data should be recorded in an equipment log. If the device is not functioning properly or fails any of the above tests, the device has to be repaired.

- 8 The device and accessories are to be disposed of according to local regulations after their useful lives. Alternatively, they can be returned to the dealer or the manufacturer for recycling or proper disposal. Batteries are hazardous waste. Do NOT dispose them together with house-hold garbage.
-
-

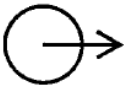
1.3 Symbols

No.	Symbol	Definition
1		CE marking
2		Disposal method
3	Rx Only	Caution: Federal (U.S.) law restricts this device to sale by or on the order of a physician.
4		Operating instructions
5		Caution
6		MR Unsafe – keep away from magnetic resonance imaging (MRI) equipment
7		Current: Direct
8		TYPE B APPLIED PART
9	P/N	Part Number
10		SERIAL NUMBER
11		Date of manufacture
12		MANUFACTURER
13		AUTHORISED REPRESENTATIVE IN THE EUROPEAN COMMUNITY
14		General symbol for recovery/recyclable
15		Power adapter connector

16		Headphones
17		Output
18 *	<p>ETL CLASSIFIED</p>  <p>Intertek 4005997</p>	<p>Conforms to UL Std. 60601-1, IEC Std. 60601-2-37 Certified to CSA Std. C22.2 No 601.1, CSA Std. C22.2 No 60601-2-37,</p>
19		<p>Refer to User Manual (Background: Blue; Symbol: White)</p>
20		<p>Warning (Background: Yellow; Symbol&Outline: Black)</p>

NOTE:

- 1) * The symbol for UL is only for UL model.
- 2) The user manual is printed in black and white.

Chapter 2 Doppler and Accessories

2.1 Features

There are five different models available: SD3 LITE, SD3, SD3 PLUS, SD3 PRO and SD3 VASCULAR.

SD3 LITE and **SD3 VASCULAR** are for simple auscultation (intermittent listening). **SD3**, **SD3 PLUS** and **SD3 PRO** not only detect fetal heart sound; they also display the fetal heart rate on an OLED screen.

The features of the Dopplers are listed in the following chart.

Model Function	SD3 LITE	SD3	SD3 PLUS	SD3 PRO	SD3 VASCULAR
Display Panel	×	✓	✓	✓	×
LED Indicator	✓	×	×	×	✓
No Signal Auto Shutdown	×	✓	✓	✓	×
HR Display	×	✓	✓	✓	×
Power Display	×	✓	✓	✓	×
Low Power Hint	✓	✓	✓	✓	✓
Noise Reduction	×	×	✓	✓	×
Audio Play	✓	✓	✓	✓	✓
Volume Adjustable	✓	✓	✓	✓	✓
Earphone Socket	✓	✓	✓	×	✓
Record/PC Upload	×	×	×	✓	×
Probe Auto Shutdown	×	×	✓	✓	×
Probe Changeable	✓	✓	✓	✓	✓
8 MHz Waterproof Probe	Optional	Optional	Optional	Optional	Optional
5 MHz Waterproof Probe	Optional	Optional	Optional	Optional	Optional
4 MHz Waterproof Probe	Optional	Optional	Optional	Optional	✓

3 MHz Waterproof Probe	✓	✓	✓	✓	✗
2 MHz Waterproof Probe	Optional	Optional	Optional	Optional	✗
Portable bag	✓	✓	✓	✓	✓
Power Adapter	✗	✗	✓	✓	✗
AA size Alkaline Battery	Optional	Optional	✗	✗	Optional
Rechargeable NI-MH Battery/Charger	Optional	Optional	✗	✗	Optional
Charge Stand	✗	✗	Optional	Optional	✗
Charging the Doppler	✗	✗	✓	✓	✗
Rechargeable Lithium Battery	✗	✗	✓	✓	✗
Trolley	Optional	Optional	Optional	Optional	Optional
Gel	✓	✓	✓	✓	✓

✓ = configured ✗ = not available

For the Essential Performance of SD3 series, refer to Appendix 1 in details.

2.2 Main Unit

NOTE:

The pictures and interfaces in this manual are for reference only.

2.2.1 Appearance

Take 2 MHz obstetrical probe for example.

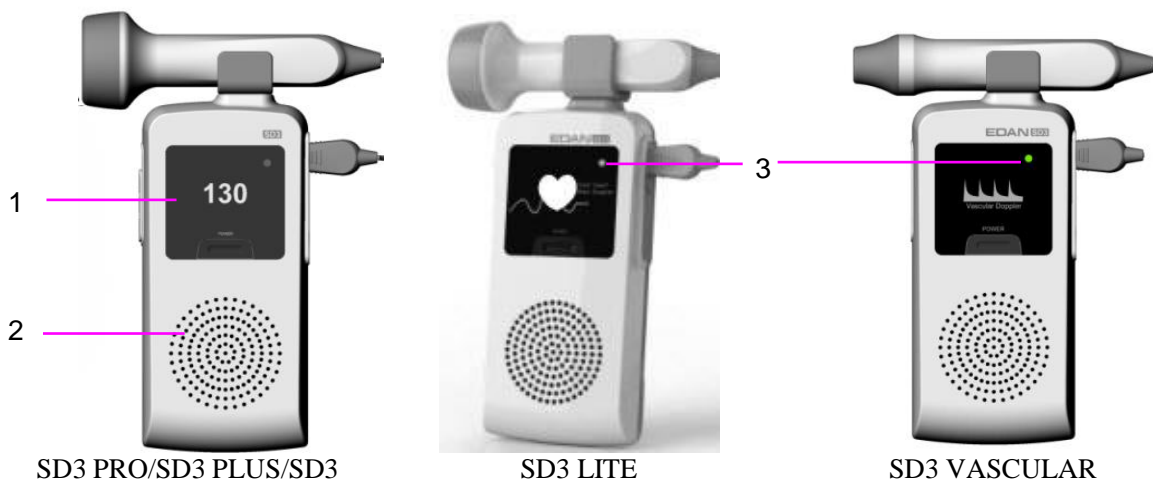

Figure 2-1 Front Panel

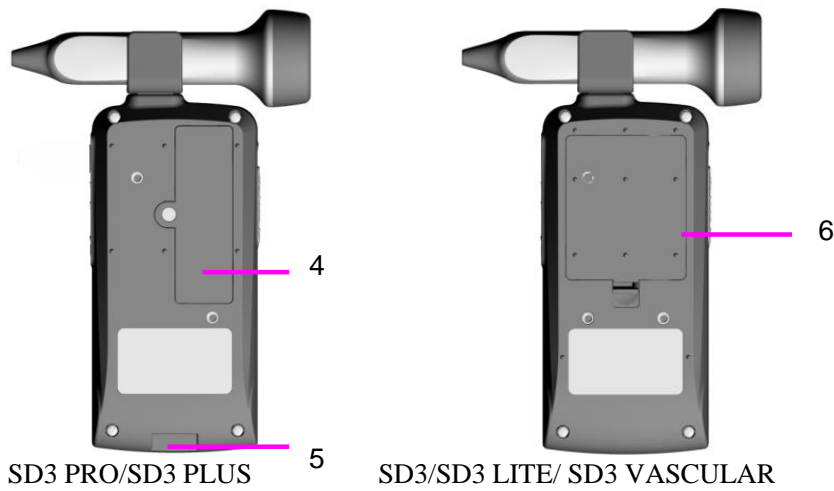

Figure 2-2 Rear Panel

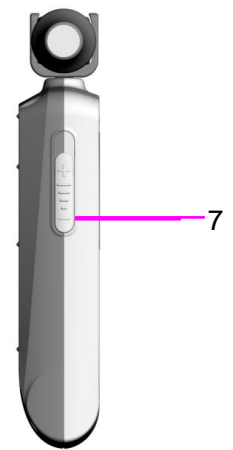

Figure 2-3 Left Panel

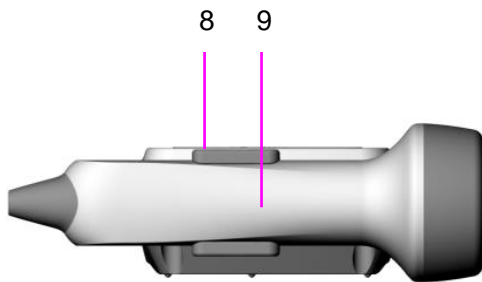

Figure 2-4 Top Panel

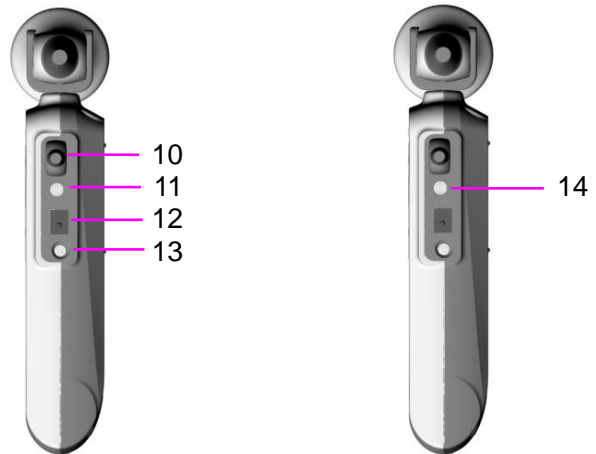

Figure 2-5 Right Panel

1	Display Panel (SD3 PRO/SD3/SD3 PLUS)	2	Speaker	3	Working State Indicator (SD3 LITE/SD3 VASCULAR)
4	Battery Compartment (SD3 PLUS/SD3 PRO)	5	Charge Stand Socket (SD3 PLUS/SD3 PRO)	6	Battery Compartment (SD3 LITE/SD3/SD3 VASCULAR)
7	Volume Control	8	Probe Holder	9	Probe
10	Probe Socket	11	Audio Socket (SD3 PRO)	12	Charge Socket (SD3 PLUS/SD3 PRO)
13	Record Button (SD3 PRO)	14	Earphone Socket (SD3 LITE/SD3/SD3 PLUS/SD3 VASCULAR)		

2.2.2 Display Panel

For **SD3**, **SD3 PRO**, and **SD3 PLUS**, the OLED is shown as follows:

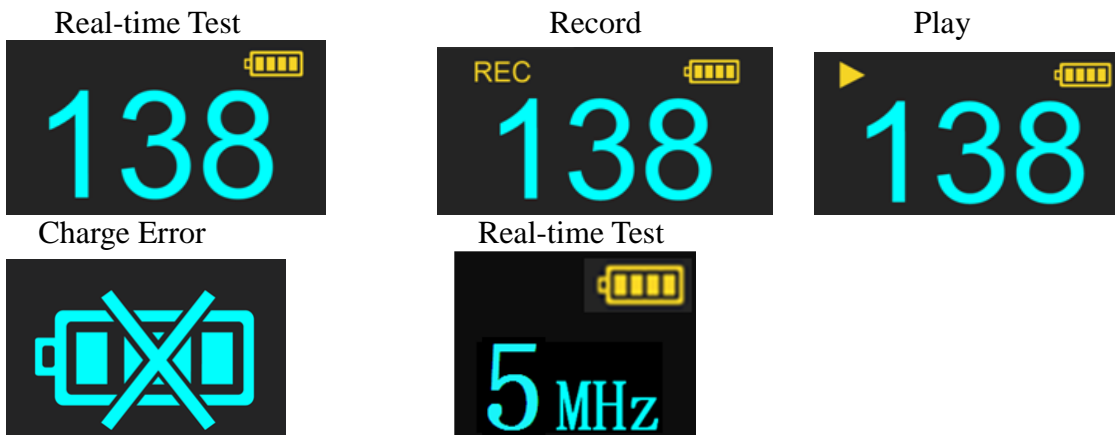



Figure 2-6 OLED Display

When 4/5/8 MHz vascular probe is plugged in, the OLED displays the probe type instead of the FHR.

No.	Symbol	Description
1		HR being calculated
2		Full capacity 3/4 capacity 2/4 capacity 1/4 capacity Empty, the flickering interface prompts replacement or charging of battery.
3		HR: 50-240
4		SD3 PRO: in playing status
5		SD3 PRO: in recording status
6		The machine is not connected to the probe.
7		Probe frequency
8		Charge interface: Electric energy pane refreshed from negative polarity to positive polarity charge completed

		charge error
--	---	--------------

For SD3 LITE without OLED, the LED is shown as follows:

Power on	Green
Power off	Off
Low capacity	Orange
Probe off	Flickering green
Probe off and low capacity	Flickering orange

2.2.3 Buttons

There is a push button (**REC/PLAY**), a volume control button and a power button on the main unit of the Doppler. Their primary functions are as follows:

(1) **REC/PLAY** 

(Only for **SD3 PRO**)

Function: Start/ stop recording or playing fetal heart sound.

(2) **Volume Control Indicator** 

Function: Adjust volume. Rotate the volume gear toward “+” to turn up the volume, while rotate it toward “-” to turn down the volume.

(3) **Power** 

Function: Power the Doppler on or off.

2.2.4 Socket

The two sockets are located on the side panel of the Doppler.

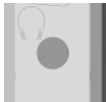
(1) **Earphone socket** : (SD3 LITE, SD3, SD3 PLUS, SD3 VASCULAR) for outputting audio signals, the earphone or line-in cable connects to the Doppler via this socket.

Audio output : (SD3 PRO) for outputting audio signals.



(2) **Charge socket** : (SD3 PRO, SD3 PLUS) for charging the battery, the dedicated power adapter connects to the Doppler via this socket.

NOTE:

Accessory equipment connected to the analog and digital interfaces must be certified according to the respective IEC/EN standards (e.g. IEC/EN 60950 for data processing equipment and IEC/EN 60601-1 for medical equipment). If in doubt, consult our technical service department or your local distributor.

2.2.5 Probe Socket

The probe socket is as shown in figure 2-7.



Figure 2-7 Probe socket

Connect the probes supplied by the manufacturer to the Doppler through the probe socket.

CAUTION

- 1 Do not try to connect any other plug to the probe socket except the plug of the probes mentioned above.
- 2 Do not stretch the probe cable for more than two meters long.

2.2.6 Batteries

SD3 LITE, **SD3** and **SD3 VASCULAR** are powered either by three alkaline batteries or three rechargeable NI-MH batteries.

SD3 PLUS and **SD3 PRO** are powered by a lithium battery.

NOTE:

The alkaline battery and rechargeable NI-MH battery can be replaced by those of identical specifications purchased locally.

Alkaline battery: AA, LR6, 1.5 V.

Rechargeable NI-MH battery: AA, R6, 1.2 V.

2.3 Probes

2.3.1 Waterproof Obstetrical Probes

2 MHz/3 MHz waterproof obstetrical probes can be connected to the main unit for fetal heart examining.

The 2 MHz obstetrical probe features in deep penetration and is designed for use during the third trimester pregnancy. The 3 MHz obstetrical probe features in high sensitivity and is designed for use as early as 9 weeks.

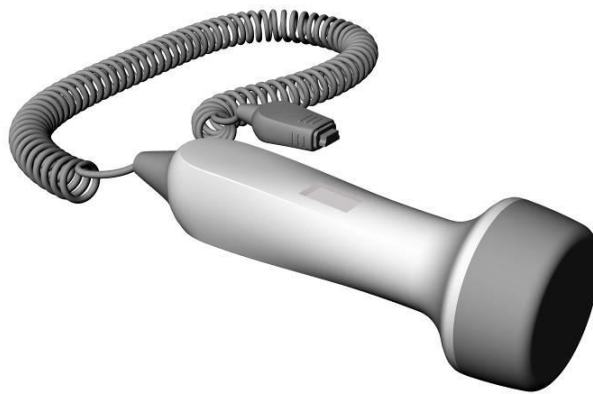

Figure 2-8 2/3 MHz obstetrical probe

2.3.2 Waterproof Vascular Probes

The 4 MHz/5 MHz/8 MHz waterproof vascular probes can be connected to the main unit for artery and vein blood flow examining.

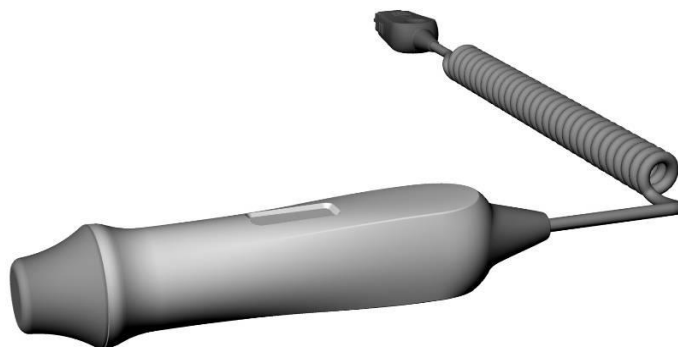

Figure 2-9 4/5/8 MHz Vascular Probes

Chapter 3 Basic Operation

NOTE:

To ensure that the Doppler works properly, please read this chapter and *Chapter 1 Safety Guide* before operation; follow the steps when connecting all the components.

3.1 Opening the Package and Checking

Open the package; take out the Doppler and accessories carefully. Keep the package for possible future transportation or storage. Check the components according to the packing list.

- ◆ Check for any mechanical damage.
- ◆ Check all the cables and accessories.

If there is any problem, contact us or your local distributor immediately.

3.2 Installing/Replacing Battery

● SD3 LITE, SD3, SD3 VASCULAR

Battery Installation

WARNING

- 1 Replace alkaline or NI-MH batteries with those of identical specifications provided by the manufacturer or purchased locally. Replace lithium batteries with only those provided by the manufacturer. See *Appendix 1 Product Specifications* for details about battery specifications.
 - 2 If the batteries have been inserted incorrectly, the Doppler will not function or it will be damaged.
-
-

Open the battery compartment by depressing the tab and pulling outward the battery door. Insert the battery such that the spring contacts are loaded and then press the battery firmly into place. The direction of the batteries should comply with the polar mark on the cover. Reversed connection is forbidden. After all three have been inserted, replace the battery door.

Battery Removal

Take out the battery in reverse order. Open the battery compartment by depressing the tab and pulling outward the battery door. Remove the existing drained batteries by pushing on the end of the battery that compresses the battery contact spring and lifting upwards. It is acceptable to carefully use a simple tool, such as a pen, to assist in lifting the batteries out.

● SD3 PLUS, SD3 PRO

Battery Installation

- 1) Remove the screws of the battery compartment using a cross-head screw driver. Remove the battery compartment cover.
- 2) Put the battery in the compartment.
- 3) Shut the battery compartment cover and fix it with the screws.

Battery Removal

Remove the battery in reverse order.

NOTE:

- 1 If a rechargeable battery is outfitted, charge it fully each time after using the device to ensure the electric power is enough.
- 2 When the battery configuration is provided, after the device is transported or stored, the battery must be charged. Connecting to power supply will charge the battery no matter if the Doppler is powered on.
- 3 The installation of battery must be carried out by qualified personnel authorized by EDAN.

3.3 Probe Operation

(1) Taking out the probe

Hold the main unit with one hand. Pinch the probe and pull it outwards using mild force.

(2) Placing the probe

Hold the main unit with one hand. Pinch the probe and align it with the probe holder. Push the probe inwards using mild force until it clicks in position.

(3) Replacing the Probe

Remove the old probe:

Switch off the Doppler; hold the main unit with one hand and pinch the jacket of the mini USB socket. Lift the jacket up slightly and pull it out with mild force; take out the probe.

CAUTION

Do not pull the probe cable directly.

Replace it with a new probe:

Put the USB socket of new probe into the probe interface of the Doppler.

NOTE:

Place the temporarily unused probe carefully and avoid falling off, splash or stress, etc. When the Doppler is not used for a long time, it's recommended to connect the probe to the Doppler and keep them safely in the package.

3.4 Switching On

Press the **POWER** button on the front panel to switch on the Doppler, the OLED displays



If the probe is not connected or poorly connected, the OLED displays . You should reconnect the probe properly.

When the probe is well connected, the OLED shows the probe frequency



3.5 Switching Off

Press the **POWER** button on the front panel to switch off the Doppler.

For **SD3**, **SD3 PRO** and **SD3 PLUS**, it switches off automatically if there is no input signal or no operation is performed for 60 seconds.

For **SD3 PRO** and **SD3 PLUS**, it switches off automatically if the probe is replaced in the probe holder.

3.6 Replacing/Charging the Battery

3.6.1 Battery Energy Indication

After switched on, the Doppler gives indication of battery energy.

For **SD3 PRO**, **SD3** and **SD3 PLUS**, there is a battery symbol in the up right corner of OLED. The panes in it indicate the battery electric energy.



The panes disappear gradually with the energy consumption. When the energy is low, the empty

battery symbol flashes. Approximately five minutes later, the Doppler shuts down automatically. You should replace the batteries or charge the rechargeable batteries.

3.6.2 Replacing Alkaline Batteries

CAUTION

Make sure the Doppler is shut down before charging the battery or opening the battery compartment.

When the alkaline batteries are low in energy, they should be removed from the main unit, by using the procedures described in section 3.2 *Installing/Replacing Battery*. Dispose of them according to local regulations.

New alkaline batteries with identical specifications are required. Install them to the Doppler as introduced in section 3.2.

WARNING

DO NOT CHARGE THE ALKALINE BATTERY.

3.6.3 Charging the NI-MH Batteries

When the rechargeable NI-MH batteries are low in energy,

- 1) Take the NI-MH batteries out from the main unit by using the procedures described in section 3.2 *Installing/Replacing Battery*.
- 2) Replace them with new batteries of identical specifications, or charge them with the provided charger.

To charge the rechargeable NI-MH batteries,

- 1) Fit the NI-MH batteries in the charger slots properly. Make sure the direction of the batteries complies with the polar marks in the slots.
- 2) Plug the charger into an AC power supply socket. During charging, the indicators of the corresponding charger slots light up in red.
- 3) When the charging indicators turn green, the batteries are fully charged (about 5 hours are needed). Take the batteries out from the charger and reinstall them to the Doppler.

The specifications of the provided charger are as follows:

Input: AC 100-240 V, 50/60 Hz

Output: 1-2 AA@1000 mA, 3-4 AA@500 mA

NOTE:

If the charging indicators are flashing in red, it indicates that the batteries are defective or non-rechargeable or that short circuit occurs.

WARNING

Make sure the batteries are not connected reversely before plugging the charger into the power socket.

3.6.4 Charging the Doppler (SD3 PLUS, SD3 PRO)

Put the plug of the power adapter into the charge socket of the Doppler, and connect the power adapter to a power supply socket.

During charging, a battery sign appears on the OLED with continuously changing energy sign. When the charging indicator shows full status, the battery finishes charging. Remove the power adapter plug and the Doppler is ready for examining again.

The specifications of the provided power adapter are as follows:

Input: AC 100-240 V, 50/60 Hz, 0.2 A

Output: DC 5 V, 1 A

3.6.5 Charging the Charge Stand

For the Doppler equipped with a charge stand, put the plug of the power adapter into the charge socket of the charge stand, and then connect the power adapter to a power supply socket.

The specifications of the provided charge stand are as follows:

Input: DC 5 V, 1 A

Output: DC 5 V, 1 A

The specifications of the provided power adapter are as follows:

Input: AC 100-240 V, 50/60 Hz, 0.2 A

Output: DC 5 V, 1 A

The charge stand can be put on a table or fixed on the wall as below.

On a table: Put the charge stand on a flat table.

On the wall: Aim the two bracket holes in the back of the charge stand to the wall, leave two marks and drill in the marked place. Screw in each hole and make sure the screws are fixed in the wall. Aim the bracket holes to the screws on the wall and fix the screws in the hole and tighten the screws.

The Doppler can be charged when placed in the charge stand.



Figure 3-1 On a Table



Figure 3-2 On the Wall

NOTE:

The Doppler is not available for examining during charging.

WARNING

- 1 The charge stand can be fixed only on a concrete wall.
 - 2 When you need to install the charge stand a second time, drill new holes and change the screws.
 - 3 The charger and the power adapter meet the requirements of Standard IEC60950, and they should be placed outside the patient environment when they are working (1.5 m away from the patient).
-

Chapter 4 Examining

4.1 FH Examining

Before applying the Doppler for fetal heart (FH) examining, a proper probe should be chosen. The 3 MHz waterproof probe is used for more than 9-week gestation and the 2 MHz is used for more than 12-week gestation.

NOTE:

In some cases, fetal heart beats at 9 weeks gestation cannot be detected due to the maternal physical difference and the operator's technique.

Perform fetal heart examining using the following procedures:

- 1) Confirm the fetus's position by hand.
- 2) Determine the probable probe location for optimal FHR examining.
- 3) Take out the probe and switch on the Doppler.
- 4) Apply a certain amount of coupling gel to the probe faceplate and place the probe against the abdomen at the predetermined location. Move the probe around or tilt it until clear and rhythmic heart sound is heard from the headphone or speaker. At the same time, a numeric FHR is displayed on the OLED (except **SD3 LITE** and **SD3 VASCULAR**).

138

NOTE:



- 1 The best quality records will only be obtained if the probe is placed in the optimum position.
- 2 Positions with strong placental sounds or umbilical blood flow sound should be avoided.
- 3 If the fetus is in the cephalic position and the mother is supine, the clearest heart sound will normally be found on the midline below the umbilicus. During examining, the pregnant woman's prolonged lying in the supine position should be avoided owing to the possibility of supine hypotension. Sitting up or lateral positions are preferable and may be more comfortable.
- 4 It is impossible to examine FHR unless a fetal heart sound is present. The fetal pulse can be distinguished from the maternal pulse by feeling the mother's pulse during the examination.

- 5 When applied to the patient, the ultrasound transducer may warm slightly (less than 5°C (9°F) above ambient temperature). When NOT applied, the ultrasound transducer may warm slightly (less than 4°C (7.2°F) above ambient temperature).

4.2 FH Sound Recording and Playing

This function is only available with **SD3 PRO**.

Recording:



Press and hold the  button for three seconds, the machine starts recording, and the OLED reads .

The longest record time is 240 seconds. When the time is up or the  button is pressed again, the Doppler stops recording and returns to the real-time status.

NOTE:

Only the last set of recorded fetal heart sounds is saved in the Doppler. It is cleared when new sounds are recorded.

Playing:

Press the  button once, the machine plays the recorded sound, and the OLED reads .



When the recorded sound comes to the end or the  button is pressed again, the Doppler stops playing and returns to the real-time status.

NOTE:

Observe the OLED, pay attention not to mistake the recorded fetal heart sound for the real-time sound.

4.3 FH Sound Recording by PC

4.3.1 Recording Sounds

1. Insert one plug of the special line-in cable supplied by the manufacturer to the audio input socket (the socket with the symbol “”) of the PC. If the PC has no audio input socket, insert the plug into the microphone socket (the socket with the symbol “”).

2. Turn on PC and run the sound recorder (Click on **Start > Programs > Accessories > Entertainment > Sound Recorder**). Perform FHR examination with the method described in section 4.1. When the ideal signal is detected, unplug the earphone (if it's connected) and insert the other plug of the audio cable into the earphone socket on the Doppler.
3. Click on the start key to start recording. You can record 60 seconds each time. When the time is up, click on the start key again to keep on recording.
4. Click on the stop key to stop recording.
5. Click on **File > Save**, input the file name, select a folder and click on **Save** to save the signals in a “.wav” file.

To start new recording, click on **File > New**.

4.3.2 Playing Sound Files

The recorded sounds are saved as waveform (.wav) files in your computer.

You can play the waveform file with the sound recorder. Run the sound recorder, click on **File > Open**, search for the folder and select the file, click on **Open** to load the file, and then click on the play key.

If you have any other program that supports waveform (.wav) files installed on your PC, double-click on the file to play it.

4.3.3 Burning CD or Sending in Email

The waveform files saved in your PC are normal audio data files. You can burn them into CDs or e-mail to whomever you want.

4.3.4 Record Troubleshooting

If there is audio output from the speaker or earphone, but the PC recorder does not have any input. (The green line recording area has no waveform.) The reason could be:

1. Poor connection of the audio cable between the Doppler and the PC.
 - Check the plugs of the cable and re-connect it if any poor connection is detected.
2. The audio cable has been plugged to the wrong socket of the PC, instead of the audio input socket or the microphone socket.
 - Insert the plug to the right socket.
3. The Line in or microphone is muted on PC.
 - Change the setting of the PC in these steps:
 - 1) Double-click on the volume symbol in the bottom right corner of your desktop.

- 2) If the line in or/and microphone volume control is/are not shown in the Volume Control menu, click on **Options > Properties**, tick **Line In** and **Microphone** and click on **OK**.
- 3) Make sure **Line In** and **Microphone** is not mute and exit.
- 4) Start new recording.

4.4 Vascular Examining (Optional)

WARNING

The Doppler is not intended for ophthalmic use. Do not use it for examining ophthalmic vessels, or any other procedures which may cause the ultrasound beam to pass through the eye.

4 MHz, 5 MHz or 8 MHz vascular probes are to be connected to the Doppler to perform vascular examination.

Choose the appropriate probe as required. The probe with low frequency has a deeper penetration depth, while the probe with high frequency has better resolution and wider detecting range. The 4 MHz vascular probe is optimized for examining blood vessels; the 5 MHz vascular probe is optimized for examining deeper vessels, and the 8 MHz vascular probe is optimized for examining surface vessels.

Apply a liberal amount of gel on the site to be examined. Place the probe at a 45 °angle on the skin over the vessel to be examined. Adjust the position of the probe to obtain the loudest blood flow sound. Refer to figure 4-1 for the probe sites:

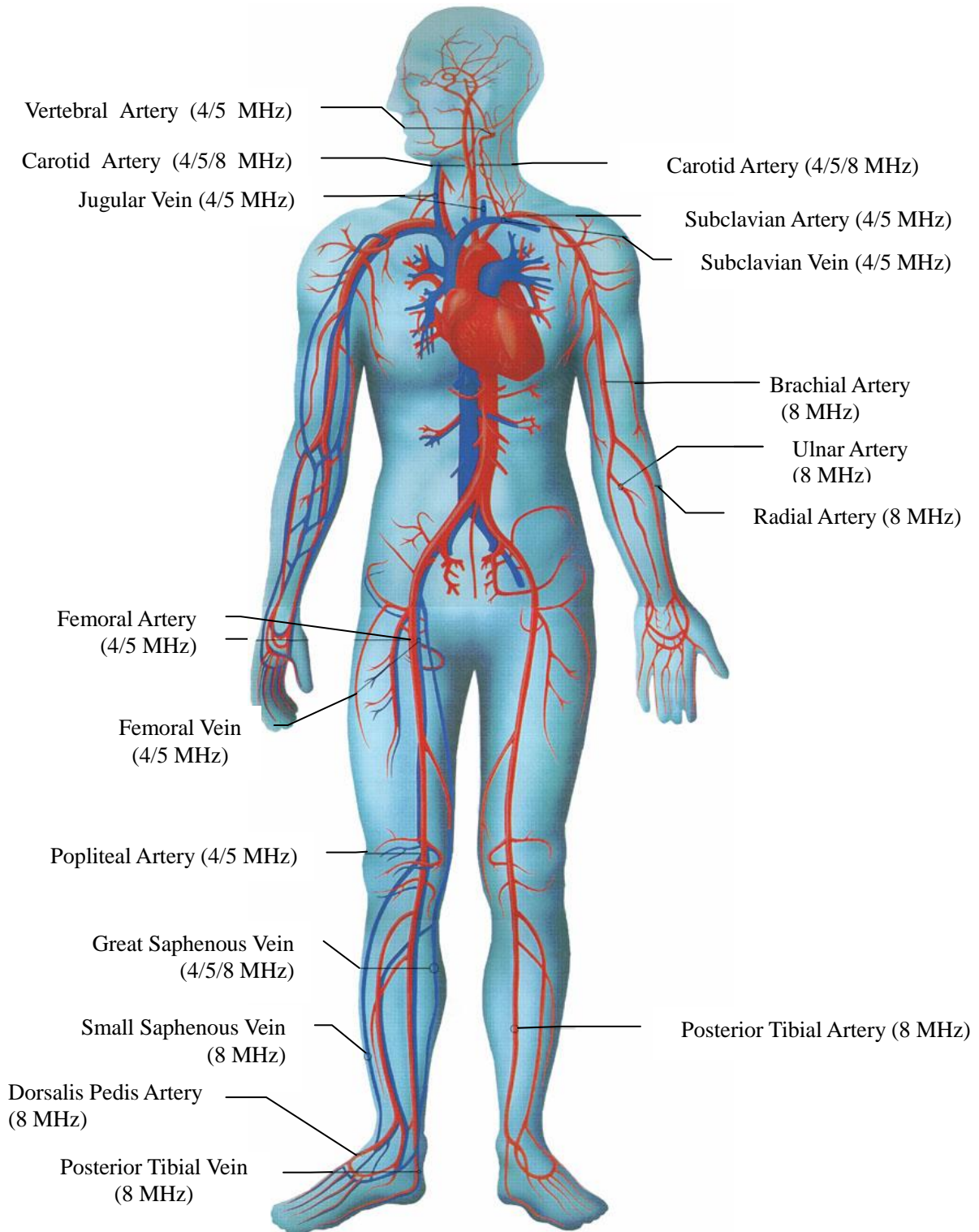

Figure 4-1 Probe sites

For best results, keep the probe as still as possible once the optimum position is found. Adjust the volume as required. High pitched pulsatile sounds are emitted from arteries while veins emit a non-pulsatile sound similar to a rushing wind.

Vascular examination only provides audio signals of arteries and veins. The OLED screen always displays the probe frequency.

NOTE:

When applied to the patient, the ultrasound transducer may warm slightly (less than 6°C (10.8°F) above ambient temperature). When NOT applied, the ultrasound transducer may warm slightly (less than 6°C (10.8°F) above ambient temperature).

4.5 Completing Examining

After examining,

- 1) Switch off the Doppler.
- 2) Wipe the remaining gel off the patient and the probe with a clean soft cloth or tissue.
- 3) Place the probe back to the holder.

Chapter 5 Maintenance

5.1 Maintenance

You must check that the equipment does not have visible evidence of damage that may affect the patient and the operator's safety or the Doppler's capability before each use. Pay special attention to the cracks on the probe and the cable before immersing them into conductive fluid. If the damage is evident, replacement is recommended.

The probe is frangible and must be handled with care.

Wipe the remaining gel after use to prolong the probe life.

The overall check of the Doppler, including safety check and function check, should be performed by qualified personnel every 12 months, and each time after service. Besides the above requirements, comply with local regulations on maintenance and measurement.

5.2 Cleaning

Before cleaning, switch off the Doppler.

Keep the exterior surface of the device clean and free of dust and dirt.

Clean the exterior surface of the main unit with a dry, soft cloth. If necessary, clean it using a soft cloth dampened with mild near neutral detergent, ethanol (75%) or isopropanol (70%), and then wipe it dry with a dry cloth immediately.

Wipe the remaining coupling gel off the probe. Clean it using a soft cloth dampened with mild near neutral detergent, ethanol (75%) or isopropanol (70%), and then air-dry it or wipe it dry with a dry cloth.

CAUTION

- 1 Do not use strong solvent, such as acetone.
 - 2 Never use an abrasive such as steel wool or metal polish.
 - 3 The main unit is not waterproof. Do not immerse any part of it into liquid.
 - 4 Avoid pouring liquids on the main unit while cleaning.
 - 5 Do not remain any solution on the surface after cleaning.
 - 6 Only the body and cable of the probe are waterproof. Do not immerse the probe socket into any liquid.
-

5.3 Disinfection

In normal use the main unit does not need disinfection. In case of being soiled, clean the main unit case and then disinfect it by wiping it with a soft cloth dampened with ethanol (75%) or isopropanol (70%). Then wipe it dry with a dry cloth.

After each use, clean the probe and then disinfect it by wiping it with a soft cloth dampened with

ethanol (75%) or isopropanol (70%). Then wipe it dry with a dry cloth.

CAUTION

Pay attention not to immerse the probe socket into the disinfectant.

5.4 Sterilization

Do not sterilize the Doppler, unless this is necessary according to your hospital regulation.

NOTE:

After cleaning or disinfection, check if the Doppler functions well. If any problem is detected, please contact the manufacturer for service before reusing it.

Checking Item	Checking Method
Visual Check	Inspect the Doppler for any damage.
Function Check	Check if the Doppler can be switched on or off properly (see 3.4 <i>Switching On</i> and 3.5 <i>Switching Off</i>). When the Doppler is switched on, check if the display panel works as described in 2.2.2 <i>Display Panel</i> ; touch the probe faceplate gently with your hand and check if the Doppler gives out sound normally.

Chapter 6 Warranty and Service

6.1 Warranty

EDAN warrants that EDAN's products meet the labeled specifications of the products and will be free from defects in materials and workmanship that occur within warranty period.

The warranty is void in cases of:

- a) damage caused by mishandling during shipping.
- b) subsequent damage caused by improper use or maintenance.
- c) damage caused by alteration or repair by anyone not authorized by EDAN.
- d) damage caused by accidents.
- e) replacement or removal of serial number label and manufacture label.

If a product covered by this warranty is determined to be defective because of defective materials, components, or workmanship, and the warranty claim is made within the warranty period, EDAN will, at its discretion, repair or replace the defective part(s) free of charge. EDAN will not provide a substitute product for use when the defective product is being repaired.

6.2 Contact information

If you have any question about maintenance, technical specifications or malfunctions of devices, contact your local distributor.

Alternatively, you can send an email to EDAN service department at: support@edan.com.cn.

Appendix 1 Product Specifications

Product Name: Ultrasonic Pocket Doppler

Model:

SD3 LITE, SD3, SD3 PLUS, SD3 PRO, SD3 VASCULAR

Safety:

Complies with: IEC 60601-1:2005, EN 60601-1:2006, IEC 60601-1-2:2014,
EN 60601-1-2:2015, IEC/EN 61266:1994, EN 60601-2-37: 2008,
IEC 60601-2-37:2007

Classification:

Anti-electric Shock Type: Internally powered equipment

Anti-electric Shock Degree: Type B equipment 

Degree of Protection against Harmful Ingress of Water:

Main Unit: Ordinary equipment (Sealed equipment without liquid proof)

Probes: IPX8 Water Ingress Protection Code

Degree of Safety in Presence of Flammable Gases: Equipment not suitable for use in presence of flammable gases

Working System: Continuous running equipment

EMC: CISPR 11 Group 1 Class B

Physical Characteristic:

Main Unit

Size: 168 mm x 31 mm x 67 mm

Weight: about 350 g (including the battery)

Probe

Weight: <100 g

Cable Length: 2 m

Size (obstetrical probe): 39 mm x 140 mm

Size (vascular probe): 25 mm x 115 mm

Charge Stand

Size: 96 mm x 93 mm x 100 mm

Weight: <200 g

Environment:

Working:

Temperature:	+5 °C ~ +40 °C (+41 °F ~ +104 °F)
Humidity:	25% RH ~ 80% RH(non-condensing)
Atmospheric Pressure:	86 kPa ~ 106 kPa

Transport and Storage:

Temperature:	-20 °C ~ +55 °C (-4 °F ~ +131 °F)
Humidity:	25% RH ~ 93% RH (non-condensing)
Atmospheric Pressure:	70 kPa ~106 kPa

Display:

0.96" OLED double color screen

FHR Performance (Essential Performance):

FHR Measuring Range:	50 bpm ~ 240 bpm
Resolution:	1 bpm
Accuracy:	±2 bpm

Sensitivity: 9 weeks gestation (3 MHz)

Audio Output Power: 2 W

Recording and Playing:

Audio Sampling Frequency:	4 kHz
Recording Length:	240 seconds

Auto Shut down:

- 1 minute after no signal or operation, auto shut down
- Probe replacement, auto shut down

Recommended Battery Type:

- Alkaline battery (AA LR6 1.5 V)
- Rechargeable NI-MH battery (AA R6 1.2 V)

Ultrasonic Gel:

- pH: 5.5~8.0
- Acoustic Impedance: $1.5 \times 10^6 \sim 1.7 \times 10^6$ Pa · s/m (in 35 °C(95 °F))

Battery Supply

Type	Battery
Internal battery	<ul style="list-style-type: none"> ◆ Support 3 AA alkaline battery LR6 Normal working time: ≥ 10 hours (recommended battery) (Please use the new battery in 22 °C~26 °C (71.6 F~78.8 F), when you plug the probe to start simulated monitoring.) ◆ Support 3 AA rechargeable NI-MH battery R6 <ol style="list-style-type: none"> 1) Normal working time: ≥ 10 hours (Please use the newly charged battery in 22 °C~26 °C (71.6 F~78.8 F), when you plug the probe to start simulated monitoring.) 2) Charge mode: rechargeable NI-MH battery charger 3) Charge time: about 5 hours ◆ Support charging rechargeable lithium battery in the Doppler <ol style="list-style-type: none"> 1) Normal working time: ≥ 16 hours (recommended battery) (Please use the newly charged battery in 22 °C~26 °C (71.6 F~78.8 F), when you plug the probe to start simulated monitoring.) 2) Charge mode: charge in the Doppler 3) Charge time: ≤ 6 hours

Rechargeable Lithium Battery

Nominal Capacity:	2600 mAh
Nominal Voltage:	3.7 V
Work Temperature	Charging Temperature: 0 °C ~ +45 °C (+32 F ~ +113 F)
	Discharging Temperature: -20 °C ~ +60 °C (-4 F ~ +140 F)
Storage Temperature:	Within 1 Month 0 °C ~ +45 °C (+32 F ~ +113 F)
	1-3 Month 0 °C ~ +35 °C (+32 F ~ +95 F)
	3-12 Month 0 °C ~ +25 °C (+32 F ~ +77 F)

Ultrasound

Nominal Frequency	2.0 MHz Obstetrical Probe	2.0 MHz
	3.0 MHz Obstetrical Probe	3.0 MHz
	4.0 MHz Vascular Probe	4.0 MHz
	5.0 MHz Vascular Probe	5.0 MHz
	8.0 MHz Vascular Probe	8.0 MHz
Working Frequency	2.0 MHz Obstetrical Probe	(2.0 \pm 10%) MHz
	3.0 MHz Obstetrical Probe	(3.0 \pm 10%) MHz
	4.0 MHz Vascular Probe	(4.0 \pm 10%) MHz

	5.0 MHz Vascular Probe	(5.0±10%) MHz
	8.0 MHz Vascular Probe	(8.0±10%) MHz
2.0 MHz/3.0 MHz Obstetrical Probe	$p < 1 \text{ MPa}$ $I_{ob} < 20 \text{ mW/cm}^2$ $I_{spta} < 100 \text{ mW/cm}^2$	
4.0 MHz/5.0 MHz/8.0 MHz Vascular Probe	$p < 1 \text{ MPa}$ $I_{ob} < 25 \text{ mW/cm}^2$ $I_{spta} < 100 \text{ mW/cm}^2$	
Working Mode	Continuous wave Doppler	
Effective Radiating Area of Transducer	2.0 MHz Obstetrical Probe	(245±15%) mm ²
	3.0 MHz Obstetrical Probe	(245±15%) mm ²
	4.0 MHz Vascular Probe	(32±15%) mm ²
	5.0 MHz Vascular Probe	(32±15%) mm ²
	8.0 MHz Vascular Probe	(14±15%) mm ²

Low Output Summary Table

(for systems with no transducers having global maximum index values exceeding 1.0)

System: SD3 Series Ultrasonic Pocket Doppler

Transducer Model (MHz)	$I_{spta.3}$ (mW/cm ²)	TI Type	TI Value	MI	$I_{sppa.3}$ (W/cm ²)
CW 2.0	26.4861	TIS	0.1589	0.01936	0.02649
		TIB	0.4030		
CW 3.0	25.061	TIS	0.2891	0.01776	0.02506
		TIB	0.4628		
CW 4.0	16.845	TIS	0.1275	0.01185	0.01685
		TIB	0.1461		
CW 5.0	29.5496	TIS	0.1821	0.01281	0.02955
		TIB	0.2364		
CW 8.0	9.4761	TIS	0.0981	0.005621	0.009476
		TIB	0.0555		

Appendix 2 Ordering Information

CAUTION

Only the parts supplied by the manufacturer should be used with the Doppler.

Parts	Part Number
Probe	
2.0 MHz Obstetrical Probe	12.01.210721
3.0 MHz Obstetrical Probe	12.01.210722
4.0 MHz Vascular Probe	12.01.210875
5.0 MHz Vascular Probe	12.01.210876
8.0 MHz Vascular Probe	12.01.210877
Accessory	
Alkaline Batteries	01.21.064086
Rechargeable NI-MH Batteries	21.21.064180
NI-MH Battery Charger	01.21.064218
Lithium Battery	21.21.064198
Power Adapter (American Standard)	21.21.064158
Power Adapter (European Standard)	01.21.064161
Power Adapter (Brazilian Standard)	21.21.064184
Charge Stand	02.06.260996
Normal Carry Case	01.56.465616

Appendix 3 EMC Information

A3.1 Electromagnetic Emissions

Guidance and manufacture's declaration–electromagnetic emission		
<p>The <i>SD3 Series Ultrasonic Pocket Doppler</i> is intended for use in the electromagnetic environment specified below. The customer or the user of the device should assure that it is used in such an environment.</p>		
Emission test	Compliance	Electromagnetic environment–guidance
RF emissions CISPR 11	Group 1	The <i>SD3 Series Ultrasonic Pocket Doppler</i> uses RF energy only for its internal function. Therefore, its RF emissions are very low and are not likely to cause any interference in nearby electronic equipment.
RF emission CISPR 11	Class B	The <i>SD3 Series Ultrasonic Pocket Doppler</i> is suitable for use in all establishments, including domestic establishments and those directly connected to the public low-voltage power supply network that supplies buildings used for domestic purposes.
Harmonic emissions IEC/EN61000-3-2	Not applicable	
Voltage fluctuations /flicker emissions IEC/EN61000-3-3	Not applicable	

A3.2 Electromagnetic Immunity

Guidance and manufacture's declaration—electromagnetic immunity			
The <i>SD3 Series Ultrasonic Pocket Doppler</i> is intended for use in the electromagnetic environment specified below. The customer or the user of the device should assure that it is used in such an environment.			
Immunity test	IEC 60601 test level	Compliance level	Electromagnetic environment-guidance
Electrostatic discharge (ESD) IEC 61000-4-2	±8 kV contact ±15 kV air	±8 kV contact ±15 kV air	Floors should be wood, concrete or ceramic tile. If floor are covered with synthetic material, the relative humidity should be at least 30%.
Electrical Fast Transient/Burst IEC/EN61000-4-4	±2 kV for power supply lines ±1 kV for input/output lines	Not applicable	Not applicable
Surge IEC/EN61000-4-5	± 1 kV line(s) to line(s) ± 2 kV line(s) to earth	Not applicable	Not applicable
Voltage dips, short interruptions, and voltage variations on power supply input lines IEC/EN61000-4-11	<5%UT(>95% dip inUT) for 0.5cycle 40%UT(60%dip in UT) for 5 cycles 70%UT(30%dip in UT) for 25 cycles <5%UT(>95% dip in UT) for 5s	Not applicable	Not applicable
Power frequency (50 Hz/60 Hz) magnetic field IEC61000-4-8	30 A/m	30 A/m	Power frequency magnetic fields should be at levels characteristic of a typical location in a typical commercial or hospital environment.

A3.3 Electromagnetic Immunity

Guidance and manufacture’s declaration – electromagnetic immunity			
The <i>SD3 Series Ultrasonic Pocket Doppler</i> is intended for use in the electromagnetic environment specified below. The customer or the user of the device should assure that it is used in such an environment.			
Immunity test	IEC 60601 test level	Compliance level	Electromagnetic environment-guidance
<p>Conducted RF IEC 61000-4-6</p>	<p>3 Vrms 150 kHz ~ 80 MHz 6Vrmsc)in ISM bands between 0,15 MHz and 80 MHz</p>	<p>3 Vrms 150 kHz to 80 MHz 6Vrmsc)in ISM bands between 0,15 MHz and 80 MHz</p>	<p>Portable and mobile RF communications equipment should be used no closer to any part of the <i>SD3 Series Ultrasonic Pocket Doppler</i>, including cables, than the recommended separation distance calculated from the equation applicable to the frequency of the transmitter. Recommended separation distance: $d = 1.2\sqrt{P}$ 150 kHz to 80 MHz $d = 1.2\sqrt{P}$ 80 MHz to 800 MHz $d = 2.3\sqrt{P}$ 800 MHz to 2.7 GHz d=6 /E at RF wireless communications equipment bands (Portable RF communications equipment (including peripherals such as antenna cables and external antennas) should be used no closer than 30 cm (12 inches) to any part of the <i>SD3 Series Ultrasonic Pocket Doppler</i>, including cables specified by the manufacturer). Where P is the maximum output power rating of the transmitter in watts (W) according to the transmitter manufacturer and d is the recommended separation distance in metres (m). Field strengths from fixed RF transmitters, as determined by an electromagnetic site survey,a should be less than the compliance level in each frequency range.b Interference may occur in the vicinity of equipment marked with the following</p> <div style="text-align: center;">  </div> <p>symbol:</p>
<p>Radiated RF IEC 61000-4-3</p>	<p>3 V/m 80 MHz to 2.7 GHz</p>	<p>3 V/m 80 MHz to 2.7 GHz</p>	
<p>NOTE 1 At 80 MHz and 800 MHz, the higher frequency range applies. NOTE 2 These guidelines may not apply in all situations. Electromagnetic propagation is affected by absorption and reflection from structures, objects and people.</p>			

a Field strengths from fixed transmitters, such as base stations for radio (cellular/cordless) telephones and land mobile radios, amateur radio, AM and FM radio broadcast and TV broadcast cannot be predicted theoretically with accuracy. To assess the electromagnetic environment due to fixed RF transmitters, an electromagnetic site survey should be considered. If the measured field strength in the location in which the *SD3 Series Ultrasonic Pocket Doppler* is used exceeds the applicable RF compliance level above, the *SD3 Series Ultrasonic Pocket Doppler* should be observed to verify normal operation. If abnormal performance is observed, additional measures may be necessary, such as reorienting or relocating the *SD3 Series Ultrasonic Pocket Doppler*.

b Over the frequency range 150 kHz to 80 MHz, field strengths should be less than 3 V/m.

c The ISM (industrial, scientific and medical) bands between 0,15 MHz and 80 MHz are 6,765 MHz to 6,795 MHz; 13,553 MHz to 13,567 MHz; 26,957 MHz to 27,283 MHz; and 40,66 MHz to 40,70 MHz. The amateur radio bands between 0,15 MHz and 80 MHz are 1,8 MHz to 2,0 MHz, 3,5 MHz to 4,0 MHz, 5,3 MHz to 5,4 MHz, 7 MHz to 7,3 MHz, 10,1 MHz to 10,15 MHz, 14 MHz to 14,2 MHz, 18,07 MHz to 18,17 MHz, 21,0 MHz to 21,4 MHz, 24,89 MHz to 24,99 MHz, 28,0 MHz to 29,7 MHz and 50,0 MHz to 54,0 MHz.

Table-Test specifications for ENCLOSURE PORT IMMUNITY to RF wireless communications equipment

Test Frequency (MHz)	Brand a) (MHz)	Service a)	Modulation b)	Maximum Power(W)	Distance (m)	IMMUNITY TEST LEVEL (V/m)
385	380-390	TETRA 400	Pulse modulation b) 18Hz	1.8	0.3	27
450	430-470	GMRS 460, FRS 460	FM C) ±5 kHz deviation 1kHz sine	2	0.3	28
710	704-787	LTE Brand 13, 17	Pulse modulation b) 217 Hz	0.2	0.3	9
745						
780						
810	800-960	GSM 800/900,TE TRA 800, iDEN 820, CDMA 850, LTE Band 5	Pulse modulation b) 18 Hz	2	0.3	28
870						
930						
1720	1700-1990	GSM 1800; CDMA 1900; GSM 1900; DECT; LTE Band 1, 3, 4,25; UMTS	Pulse modulation b) 217 Hz	2	0.3	28
1845						
1970						

2450	2400-2570	Bluetooth, WLAN,802. 11 b/g/n, RFID 2450, LTE Brand 7	Pulse modulation b) 217 Hz	2	0.3	28
5240	5100-5800	WLAN 802.11 a/n	Pulse modulation b) 217 Hz	0.2	0.3	9
5500						
5785						
Note: If necessary to achieve the IMMUNITY TEST LEVEL, the distance between the transmitting antenna and the ME EQUIPMENT or ME SYSTEM maybe reduce to 1m. The 1 m test distance is permitted by IEC 61000-4-3.						
a) For some services, only the uplink frequencies are included. b) The carrier shall be modulated using a 50% duty cycle square wave signal. c) As an alternative FM modulation, 50% pulse modulation at 18 Hz may be used because while it does not represent actual modulation, it would be worst case						

A3.4 Recommended Separation Distances

Recommended separation distances between portable and mobile RF communications equipment and the SD3 Series Ultrasonic Pocket Doppler

The SD3 Series Ultrasonic Pocket Doppler is intended for use in an electromagnetic environment in which radiated RF disturbances are controlled. The customer or the user of the SD3 Series Ultrasonic Pocket Doppler can help prevent electromagnetic interference by maintaining a minimum distance between portable and mobile RF communications equipment (transmitters) and the SD3 Series Ultrasonic Pocket Doppler as recommended below, according to the maximum output power of the communications equipment.

Rated maximum output power of transmitter (W)	Separation distance according to frequency of transmitter (m)		
	150 kHz to 80 MHz $d = 1.2\sqrt{P}$	80 MHz to 800 MHz $d = 1.2\sqrt{P}$	800 MHz to 2.7 GHz $d = 2.3\sqrt{P}$
0.01	0.12	0.12	0.23
0.1	0.38	0.38	0.73
1	1.2	1.2	2.3
10	3.8	3.8	7.3
100	12	12	23

For transmitters rated at a maximum output power not listed above, the recommended separation distance d in meters (m) can be estimated using the equation applicable to the frequency of the transmitter, where P is the maximum output power rating of the transmitter in watts (W) according to the transmitter manufacturer.

NOTE 1: At 80 MHz and 800 MHz, the separation distance for the higher frequency range applies.

NOTE 2: These guidelines may not apply in all situations. Electromagnetic propagation is affected by absorption and reflection from structures, objects and people.

Appendix 4 Ultrasound Intensity and Safety

A4.1 Ultrasound in Medicine

The use of diagnostic ultrasound has proved to be a valuable tool in medical practice. Given its known benefits for non-invasive investigations and medical diagnosis, including investigation of the human fetus, the question of clinical safety with regards to ultrasound intensity arises.

There is no easy answer to the question of safety surrounding the use of diagnostic ultrasound equipment. Application of the ALARA (As Low As Reasonably Achievable) principle serves as a rule-of-thumb that will help you to get reasonable results with the lowest possible ultrasonic output.

The American Institute of Ultrasound in Medicine (AIUM) states that given its track record of over 25 years of use and no confirmed biological effects on patients or instrument operators, the benefits of the prudent use of diagnostic ultrasound clearly outweigh any risks.

A4.2 Ultrasound Safety and the ALARA Principle

Ultrasound waves dissipate energy in the form of heat and can therefore cause tissue warming. Although this effect is extremely low with Doppler, it is important to know how to control and limit patient exposure. Major governing bodies in ultrasound have issued statements to the effect that there are no known adverse effects from the use of diagnostic ultrasound, however, exposure levels should always be limited to As Low As Reasonably Achievable (the ALARA principle).

A4.3 Explanation of MI/TI

A4.3.1 MI (Mechanical Index)

Cavitations will be generated when ultrasound wave passes through and contacts tissues, resulting in instantaneous local overheating. This phenomenon is determined by acoustic pressure, spectrum, focus, transmission mode, and factors such as states and properties of the tissue and boundary. This mechanical bioeffect is a threshold phenomenon that occurs when a certain level of ultrasound output is exceeded. The threshold is related to the type of tissue. Although no confirmed adverse mechanical effects on patients or mammals caused by exposure at intensities typical of present diagnostic ultrasound instruments have ever been reported, the threshold for cavitation is still undetermined. Generally speaking, the higher the acoustic pressure, the greater the potential for mechanical bioeffects; the lower the acoustic frequency, the greater the potential for mechanical bioeffects.

The AIUM and NEMA formulate mechanical index (MI) in order to indicate the potential for mechanical effects. The MI is defined as the ratio of the peak-rarefactional acoustic pressure (should be calculated by tissue acoustic attenuation coefficient 0.3 dB/cm/MHz) to the acoustic frequency.

$$MI = \frac{P_{r, \alpha}}{f_{\text{awf}} \times C_{MI}}$$

$$C_{MI} = 1 \text{ (MPa / MHz)}$$

A4.3.2 TI (Thermal Index)

Heating of tissues is caused by absorption of ultrasound when the ultrasound energy is applied. The temperature rise is determined by the acoustic intensity, exposed area and thermophysical properties of the tissue.

In order to indicate the potential for temperature rise caused by thermal effects, the AIUM and NEMA formulate thermal index (TI). It is defined as the ratio of the total acoustic power to the acoustic power required to raise the tissue temperature by 1 °C (1.8 °F).

According to different thermophysical properties of the tissue, TI is divided into three kinds: TIS, TIB and TIC.

TIS (Soft Tissue Thermal Index): It provides an estimate of potential temperature rise in soft or similar tissues.

TIB (Bone Thermal Index): It provides an estimate of potential temperature rise when the ultrasound beam passes through soft tissue and a focal region is in the immediate vicinity of bone.

TIC (Cranial Bone Thermal Index): It provides an estimate of potential temperature rise in the cranial bones or superficial bones.

A4.3.3 Measurement Uncertainties

The uncertainties in the measurements were predominantly systematic in origin; the random uncertainties were negligible in comparison. The overall systematic uncertainties were determined as follows:

1. **Hydrophone Sensitivity:** ±23 percent for intensity, ±11.5 percent for pressure. Based on the hydrophone calibration report by ONDA. The uncertainty was determined within ±1 dB in frequency range 1-15 MHz.
2. **Digitizer:** ±3 percent for intensity, ±1.5 percent for pressure. Based on the stated accuracy of the 8-bit resolution of the Agilent DSO6012 Digital Oscilloscope and the signal-to-noise ratio of the measurement.
3. **Temperature:** ±1 percent
Based on the temperature variation of the water bath of ±1 °C (1.8 °F).
4. **Spatial Averaging:** ±10 percent for intensity, ±5 percent for pressure.
5. **Non-linear Distortion:** N/A.
No effects of nonlinear propagation were observed.

Since all the above error sources are independent, they may be added on an RMS basis, giving a total uncertainty of ±25.1 percent for all intensity values reported, ±12.7 percent for all the pressure values and ±12.6 percent for the Mechanical Index.

A4.4 Prudent Use Statement

Although no confirmed bioeffects on patients caused by exposure from present diagnostic ultrasound equipment have ever been reported, the potential exists that such bioeffects may be identified in the future. Therefore, the ultrasound should be used prudently. High levels of acoustic output and long exposure time should be avoided while acquiring necessary clinical information.

A4.5 References for Acoustic Output and Safety

1. "Bioeffects and Safety of Diagnostic Ultrasound" issued by AIUM in 1993
2. "Medical Ultrasound Safety" issued by AIUM in 1994
3. "Acoustic Output Measurement Standard for Diagnostic Ultrasound Equipment, Revision 3" issued by AIUM/NEMA in 2004
4. "Standard for real-time display of thermal and mechanical acoustic output indices on diagnostic ultrasound equipment, Revision 2" issued by AIUM/NEMA in 2004
5. "Information for Manufacturers Seeking Marketing Clearance of Diagnostic Ultrasound Systems and Transducers" issued in 2008.
6. "Medical electrical equipment—Part 2-37: Particular requirements for the basic safety and essential performance of ultrasonic medical diagnostic and monitoring equipment" issued by IEC in 2007.

A4.6 Transducer Acoustic Output Parameters List

Acoustic output reporting table for IEC60601-2-37
(IEC60601-2-37, Edition 2.1, 2015-06, table 201.103)

Transducer Model: SD3 CW2.0

Working Mode: CW mode

Working Frequency:2.0MHz

Index label		<i>MI</i>	<i>TIS</i>		<i>TIB</i>		<i>TIC</i>
			At surface	Below surface	At surface	Below surface	
Maximum index value		0.019	0.16		0.40		N/A
Index component value			N/A	0.16	N/A	0.40	
Acoustic Parameters	$p_{r, \alpha}$ at z_{MI} (MPa)	0.027					
	P (mW)		24.21		24.21		N/A
	P_{1x1} (mW)		N/A		N/A		
	z_s (cm)			2.30			
	z_b (cm)					2.73	
	z_{MI} (cm)	2.80					
	$z_{PII, \alpha}$ (cm)	2.80					
	f_{awf} (MHz)	2.00	2.00		2.00		N/A
Other Information	prf (Hz)	N/A					
	srf (Hz)	N/A					
	n_{pps}	N/A					
	$I_{pa, \alpha}$ at $z_{PII, \alpha}$ (W/cm^2)	0.026					
	$I_{spta, \alpha}$ at $z_{PII, \alpha}$ or $z_{SII, \alpha}$ (mW/cm^2)	26.49					
	I_{spta} at z_{PII} or z_{SII} (mW/cm^2)	42.63					
	p_r at z_{PII} (MPa)	0.037					
Operating control conditions	Focus(mm)	Fixed					
	Depth(mm)	Fixed					
	Frequency(MHz)	2.00					

**Acoustic output reporting table for IEC60601-2-37
(IEC60601-2-37, Edition 2.1, 2015-06, table 201.103)**

Transducer Model: SD3 CW 3.0

Working Mode: CW mode

Working Frequency:3.0MHz

Index label		<i>MI</i>	<i>TIS</i>		<i>TIB</i>		<i>TIC</i>
			At surface	Below surface	At surface	Below surface	
Maximum index value		0.018	0.29		0.46		N/A
Index component value			N/A	0.29	N/A	0.46	
Acoustic Parameters	p_r at z_{MI} (MPa)	0.031					
	P (mW)		44.65		44.65		N/A
	P_{1x1} (mW)		N/A		N/A		
	z_s (cm)			3.70			
	z_b (cm)					3.70	
	z_{MI} (cm)	3.75					
	z_{PII} (cm)	3.75					
	f_{awf} (MHz)	3.00	3.00		3.00		N/A
Other Information	prr (Hz)	N/A					
	srr (Hz)	N/A					
	n_{pds}	N/A					
	I_{pa} at z_{PII} (W/cm^2)	0.025					
	I_{spta} at z_{PII} or z_{SII} (mW/cm^2)	25.06					
	I_{spta} at z_{PII} or z_{SII} (mW/cm^2)	57.83					
	p_r at z_{PII} (MPa)	0.048					
Operating control conditions	Focus(mm)	Fixed					
	Depth(mm)	Fixed					
	Frequency(MHz)	3.00					

**Acoustic output reporting table for IEC60601-2-37
(IEC60601-2-37, Edition 2.1, 2015-06, table 201.103)**

Transducer Model: SD3 CW4.0

Working Mode: CW mode

Working Frequency:4.0MHz

Index label		<i>MI</i>	<i>TIS</i>		<i>TIB</i>		<i>TIC</i>
			At surface	Below surface	At surface	Below surface	
Maximum index value		0.012	0.13		0.15		N/A
Index component value			0.13	N/A	N/A	0.15	
Acoustic Parameters	p_r at z_{MI} (MPa)	0.024					
	P (mW)		6.69		6.69		N/A
	P_{1x1} (mW)		N/A		N/A		
	z_s (cm)			N/A			
	z_b (cm)					2.75	
	z_{MI} (cm)	2.75					
	z_{PII} (cm)	2.75					
	f_{awf} (MHz)	4.00	4.00		4.00		N/A
Other Information	prr (Hz)	N/A					
	srr (Hz)	N/A					
	n_{pds}	N/A					
	I_{pa} at z_{PII} (W/cm^2)	0.017					
	I_{spta} at z_{PII} or z_{SII} (mW/cm^2)	16.85					
	I_{spta} at z_{PII} or z_{SII} (mW/cm^2)	37.72					
	p_r at z_{PII} (MPa)	0.037					
Operating control conditions	Focus(mm)	Fixed					
	Depth(mm)	Fixed					
	Frequency(MHz)	4.00					

**Acoustic output reporting table for IEC60601-2-37
(IEC60601-2-37, Edition 2.1, 2015-06, table 201.103)**

Transducer Model: SD3 CW5.0

Working Mode: CW mode

Working Frequency:5.0MHz

Index label		<i>MI</i>	<i>TIS</i>		<i>TIB</i>		<i>TIC</i>
			At surface	Below surface	At surface	Below surface	
Maximum index value		0.013	0.18		0.24		N/A
Index component value			0.18	N/A	N/A	0.24	
Acoustic Parameters	p_r at z_{MI} (MPa)	0.029					
	P (mW)		7.65		7.65		N/A
	P_{1x1} (mW)		N/A		N/A		
	z_s (cm)			N/A			
	z_b (cm)					1.40	
	z_{MI} (cm)	1.40					
	z_{PII} (cm)	1.40					
	f_{awf} (MHz)	5.00	5.00		5.00		N/A
Other Information	prr (Hz)	N/A					
	srr (Hz)	N/A					
	n_{pds}	N/A					
	I_{pa} at z_{PII} (W/cm^2)	0.030					
	I_{spta} at z_{PII} or z_{SII} (mW/cm^2)	29.55					
	I_{spta} at z_{PII} or z_{SII} (mW/cm^2)	54.49					
	p_r at z_{PII} (MPa)	0.041					
Operating control conditions	Focus(mm)	Fixed					
	Depth(mm)	Fixed					
	Frequency(MHz)	5.00					

**Acoustic output reporting table for IEC60601-2-37
(IEC60601-2-37, Edition 2.1, 2015-06, table 201.103)**

Transducer Model: SD3 CW8.0

Working Mode: CW mode

Working Frequency:8.0MHz

Index label		<i>MI</i>	<i>TIS</i>		<i>TIB</i>		<i>TIC</i>
			At surface	Below surface	At surface	Below surface	
Maximum index value		0.0057	0.098		0.056		N/A
Index component value			0.098	N/A	N/A	0.056	
Acoustic Parameters	p_r at z_{MI} (MPa)	0.016					
	P (mW)		2.58		2.58		N/A
	P_{1x1} (mW)		N/A		N/A		
	z_s (cm)			N/A			
	z_b (cm)					2.15	
	z_{MI} (cm)	2.15					
	z_{PII} (cm)	2.15					
	f_{awf} (MHz)	8.00	8.00		8.00		N/A
Other Information	prr (Hz)	N/A					
	srr (Hz)	N/A					
	n_{pds}	N/A					
	I_{pa} at z_{PII} (W/cm^2)	0.0095					
	I_{spta} at z_{PII} or z_{SII} (mW/cm^2)	9.48					
	I_{spta} at z_{PII} or z_{SII} (mW/cm^2)	35.89					
	p_r at z_{PII} (MPa)	0.033					
Operating control conditions	Focus(mm)	Fixed					
	Depth(mm)	Fixed					
	Frequency(MHz)	8.00					

A4.7 Track1 Acoustic Output Range Summary

TRACK1 SUMMARY

		Mode of Operation
Transducer	Global Maximum Output Level	CW mode
CW2.0	Max $I_{SPTA,3}$ (mW/cm ²)	35.4722
	Min $I_{SPTA,3}$ (mW/cm ²)	17.5000
	Max $I_{SPPA,3}$ (W/cm ²)	0.03547
	Min $I_{SPPA,3}$ (W/cm ²)	0.01750
	Max MI	0.0225
	Min MI	0.0162
	Max $I_{sata@transducer\ face}$	12.77
	Min $I_{sata@transducer\ face}$	5.27
CW3.0	Max $I_{SPTA,3}$ (mW/cm ²)	30.8334
	Min $I_{SPTA,3}$ (mW/cm ²)	19.2886
	Max $I_{SPPA,3}$ (W/cm ²)	0.03083
	Min $I_{SPPA,3}$ (W/cm ²)	0.01929
	Max MI	0.0210
	Min MI	0.0146
	Max $I_{sata@transducer\ face}$	19.91
	Min $I_{sata@transducer\ face}$	15.38
CW4.0	Max $I_{SPTA,3}$ (mW/cm ²)	18.8302
	Min $I_{SPTA,3}$ (mW/cm ²)	14.8597
	Max $I_{SPPA,3}$ (W/cm ²)	0.01883
	Min $I_{SPPA,3}$ (W/cm ²)	0.01486
	Max MI	0.0125
	Min MI	0.0112
CW5.0	Max $I_{SPTA,3}$ (mW/cm ²)	32.3369
	Min $I_{SPTA,3}$ (mW/cm ²)	26.7624
	Max $I_{SPPA,3}$ (W/cm ²)	0.03234
	Min $I_{SPPA,3}$ (W/cm ²)	0.02676
	Max MI	0.0139
	Min MI	0.0117
CW8.0	Max $I_{SPTA,3}$ (mW/cm ²)	10.7050
	Min $I_{SPTA,3}$ (mW/cm ²)	8.2472
	Max $I_{SPPA,3}$ (W/cm ²)	0.01071
	Min $I_{SPPA,3}$ (W/cm ²)	0.008247
	Max MI	0.0059
	Min MI	0.0053

**Acoustic Output Reporting Table for Track1
Non-autoscanning Mode**

System : SD3Operating Mode: CW modeTransducer: CW2.0Working Frequency: 2.0 MHz

Acoustic Output		MI	$I_{spta.3}$ (mW/cm ²)	$I_{sppa.3}$ (W/cm ²)	
Global Maximum Value		0.01936	26.4861	0.02649	
Associated Acoustic Parameter	$P_{r.3}$ (MPa)	0.02738			
	W_0 (mW)		24.21	24.21	
	f_c (MHz)	2.00	2.00	2.00	
	Z_{sp} (cm)	2.80	2.80	2.80	
	Beam dimensions	$X_{.6}$ (cm)		0.4674	0.4674
		$Y_{.6}$ (cm)		0.4292	0.4292
	PD (usec)				
	PRF (Hz)				
	EBD	A_z (cm)		2.5	
E_{le} (cm)			1.25		
Operating Control Conditions	Fixed				

**Acoustic Output Reporting Table for Track1
Non-autoscanning Mode**

System : SD3Operating Mode: CW modeTransducer: CW3.0Working Frequency: 3.0 MHz

Acoustic Output		MI	$I_{spta.3}$ (mW/cm ²)	$I_{sppa.3}$ (W/cm ²)	
Global Maximum Value		0.01776	25.061	0.02506	
Associated Acoustic Parameter	$P_{r.3}$ (MPa)	0.0308			
	W_0 (mW)		44.65	44.65	
	f_c (MHz)	3.00	3.00	3.00	
	Z_{sp} (cm)	3.75	3.75	3.75	
	Beam dimensions	$X_{.6}$ (cm)		0.4278	0.4278
		$Y_{.6}$ (cm)		0.3619	0.3619
	PD (usec)				
	PRF (Hz)				
	EBD	A_z (cm)		2.5	
E_{le} (cm)			1.25		
Operating Control Conditions	Fixed				

**Acoustic Output Reporting Table for Track1
Non-autoscanning Mode**

System : SD3Operating Mode: CW modeTransducer: CW4.0Working Frequency: 4.0 MHz

Acoustic Output		MI	$I_{spta.3}$ (mW/cm ²)	$I_{sppa.3}$ (W/cm ²)	
Global Maximum Value		0.01185	16.845	0.01685	
Associated Acoustic Parameter	$P_{r.3}$ (MPa)	0.02368			
	W_0 (mW)		6.694	6.694	
	f_c (MHz)	4.00	4.00	4.00	
	Z_{sp} (cm)	2.75	2.75	2.75	
	Beam dimensions	X_{-6} (cm)		0.4584	0.4584
		Y_{-6} (cm)		0.4769	0.4769
	PD (usec)				
	PRF (Hz)				
	EBD	A_z (cm)		0.9	
E_{le} (cm)			0.45		
Operating Control Conditions	Fixed				

**Acoustic Output Reporting Table for Track1
Non-autoscanning Mode**

System : SD3Operating Mode: CW modeTransducer: CW5.0Working Frequency: 5.0 MHz

Acoustic Output		MI	$I_{spta.3}$ (mW/cm ²)	$I_{sppa.3}$ (W/cm ²)	
Global Maximum Value		0.01281	29.5496	0.02955	
Associated Acoustic Parameter	$P_{r.3}$ (MPa)	0.02862			
	W_0 (mW)		7.65	7.65	
	f_c (MHz)	5.00	5.00	5.00	
	Z_{sp} (cm)	1.40	1.40	1.40	
	Beam dimensions	X_{-6} (cm)		0.2308	0.2308
		Y_{-6} (cm)		0.3587	0.3587
	PD (usec)				
	PRF (Hz)				
	EBD	A_z (cm)		0.9	
E_{le} (cm)			0.45		
Operating Control Conditions	Fixed				

Acoustic Output Reporting Table for Track1
Non-autoscanning Mode

System : SD3

Operating Mode:

CW modeTransducer: CW8.0

Working Frequency:

8.0 MHz

Acoustic Output		MI	$I_{spta.3}$ (mW/cm ²)	$I_{sppa.3}$ (W/cm ²)	
Global Maximum Value		0.005621	9.4761	0.009476	
Associated Acoustic Parameter	$P_{r.3}$ (MPa)	0.01590			
	W_0 (mW)		2.576	2.576	
	f_c (MHz)	8.00	8.00	8.00	
	Z_{sp} (cm)	2.15	2.15	2.15	
	Beam dimensions	$X_{.6}$ (cm)		0.3348	0.3348
		$Y_{.6}$ (cm)		0.3245	0.3245
	PD (usec)				
	PRF (Hz)				
	EBD	A_z (cm)		0.6	
E_{le} (cm)			0.3		
Operating Control Conditions	Fixed				

Appendix 5 Troubleshooting

Phenomenon	Possible Cause	Solution
The speaker does not sound.	The speaker is muted.	Turn up the volume.
	Bad connection between the probe and main unit.	Make sure that the probe is well connected to the main unit.
	Main board defective.	Replace the main board.
	Speaker defective.	Replace the speaker.
	Probe defective.	Replace the probe.
The speaker sounds weak.	The volume is too low.	Turn up the volume.
	No coupling gel is applied.	Apply coupling gel on the probe acoustic surface.
	The battery is in low energy.	Replace the battery or charge the rechargeable battery.
Low sensitivity.	The probe is not placed at the optimum position.	Locate the probe at a position for optimal FHR examining.
	No coupling gel is applied.	Apply coupling gel on the probe acoustic surface.
The screen displays nothing and the speaker does not sound after the main unit is switched on.	Main board defective.	Replace the main board.
	The battery is in low energy.	Replace the battery or charge the rechargeable battery.
The speaker sounds but the screen displays nothing or displays wrong characters after the main unit is switched on.	Main board defective.	Replace the main board.
Loud noise.	The device is subject to strong electromagnetic emissions.	Make sure that the environment in which the device is operated is not subject to any source of strong electromagnetic emissions.
	Speaker defective.	Replace the speaker.
	Probe defective.	Replace the probe.
	Main board defective.	Replace the main board.
	The probe has not been taken out from the probe holder when the main unit is switched on.	Take out the probe from the probe holder before switching on the main unit.
	The battery is in low energy.	Replace the battery or charge the rechargeable battery.
	Too much coupling gel on the probe acoustic surface.	Wipe the residual coupling gel off the probe after each use.
The screen displays nothing	Power adapter defective.	Replace the power adapter.

or displays charge error when the Doppler (SD3 PLUS or SD3 PRO) is being charged.	Battery defective.	Replace the battery.
	Main board defective.	Replace the main board.
	Charge stand defective.	Replace the charge stand.

Appendix 6 Overall Sensitivity

Diameter of Target Reflector(mm)	Distance (d)(mm)	A(dB)	Two-way Attenuation $B = \sum B_a + B_w$					V_s (r.m.s) mV	V_n (r.m.s) mV	$C = 20 \log_{10} \left(\frac{V_s(r.m.s.)}{V_n(r.m.s.)} \right)$ dB	Overall Sensitivity (S=A(d)+B+C) dB		
			$\sum B$ (T: ultrasonic attenuation phantom No. B _a :dB)	B _w (dB)	B (dB)								
2.38@2 MHz	50	32.5	T	6#	6#	5#	1#	0	66.1	204.2	100.4	6.17	104.77
			B _a	66.1									
	75	36.0	T	6#	6#	5#	1#	0	66.1	174.8	85.4	6.22	108.32
			B _a	66.1									
	100	38.5	T	6#	6#	5#	1#	0	66.1	174.2	87.5	5.98	110.58
			B _a	66.1									
	200	45.5	T	6#	6#	4#	-	0	59.9	300.2	142.3	6.48	110.88
			B _a	59.9									
Doppler Frequency (Hz)		299							Velocity of Target (cm/s)		12.5		
2.38@3 MHz	50	32.5	T	6#	6#	-	-	0	87.3	94.5	49.7	5.58	125.38
			B _a	87.3									
	75	36.0	T	6#	6#	-	-	0	87.3	90.3	49.8	5.17	128.47
			B _a	87.3									
	100	38.5	T	6#	6#	-	-	0	87.3	105.2	51.5	6.04	131.84
			B _a	87.3									
	200	45.5	T	6#	6#	-	-	0	87.3	85.5	52.5	4.24	136.00
			B _a	87.3									
Doppler Frequency (Hz)		410							Velocity of Target (cm/s)		12.5		

P/N: 01.54.455714
MPN: 01.54.455714019



EDAN INSTRUMENTS, INC.
#15 Jinhui Road, Jinsha Community, Kengzi Sub-District
Pingshan District, 518122 Shenzhen, P.R.China
Email: info@edan.com.cn
TEL: +86-755-2689 8326 FAX: +86-755-2689 8330
Website: www.edan.com.cn



EC REPRESENTATIVE
Shanghai International Holding Corp. GmbH
Eiffestrasse 80, 20537 Hamburg Germany
TEL: +49-40-2513175
E-mail: shholding@hotmail.com